

DR Series



DD Motor

* cpc reserves the right to revise any information (technical details) any time without notice, for printing mistakes or any other incidental mistakes. We take no responsibility.



Features

Frameless type / DR series



1 Highest torque density & motor constant.

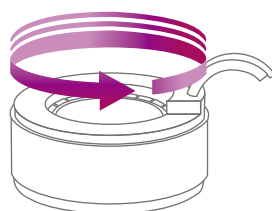

3 High heat dissipation

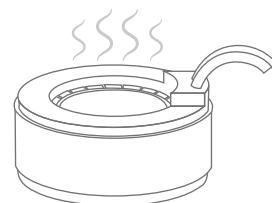

2 Large pass through

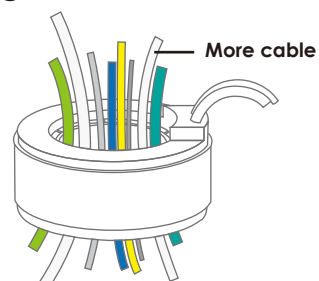

4 Cable output option

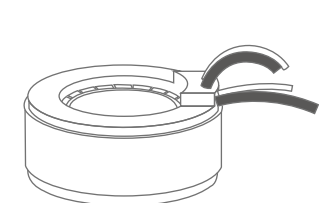

Ordering Information

DR	K	105	8	S	H	P	N	CS	0400
									Cable length (mm) : 0400 : 400 mm (Standard) Rotor : Blank
									Cable exit direction : CS : Radial CU : Axial Rotor : Blank
									Cooling : N : No cooling W : Water cooling Rotor : Blank
									Temperature sensor: P : PTC-90°C K: KTY84-130 Rotor: Blank
									H : Hall sensor. NH : No hall sensor.
									Winding code : S : Standard F : Small current D : Low voltage Rotor : Blank
									Height (mm) : 30 series 8, 16, 24, 32, 48 42.5 series 8, 16, 24, 32, 48 60 series 8, 16, 24, 48 80 series 8, 16, 24, 48, 80 105 series 8, 16, 24, 32, 48, 80 140 series 8, 16, 24, 30, 50, 70 175 series 8, 16, 24, 30, 50, 70, 100 210 series 30, 50, 70, 100
									Outside diameter of the stator (mm) : 30, 42.5, 60, 80, 105, 140, 175, 210
									Part : K : Kit S : Stator R : Rotor KH : Kit with Hall sensor
Torque motor									

* To support hall function, the rotor height need to be higher.
* Configuring table of Hall type.

	Stack Height	Stator height / Assembly height	Rotor height
30 series	8	14.8	8.6
	16	22.8	16.6
	24	30.8	24.6
	32	38.8	32.6
	48	54.8	48.6
42.5 series	8	12.5	8.6
	16	20.5	16.6
	24	28.5	24.6
	32	36.5	32.2
60 series	8	16.7	8.6
	16	24.7	16.6
	24	32.7	24.6
80 series	8	19	8.5
	16	27	16.5
	24	35	24.5
	48	59	48.5
	80	91	80.5

Unit: mm

	Stack Height	Stator height / Assembly height	Rotor height
105 series	8	27	9
	16	35	17
	24	43	25
	32	51	33
	48	67	49
140 series	8	34	9
	16	42	17
	24	50	25
	30	56	31
	50	76	51
175 series	70	96	71
	8	29	9
	16	37	17
	24	45	25
	30	51	31
	50	71	51
210 series	70	91	71
	100	121	101
	30	54	31
	50	74	51
	70	94	71
	100	124	101

Torque Overview

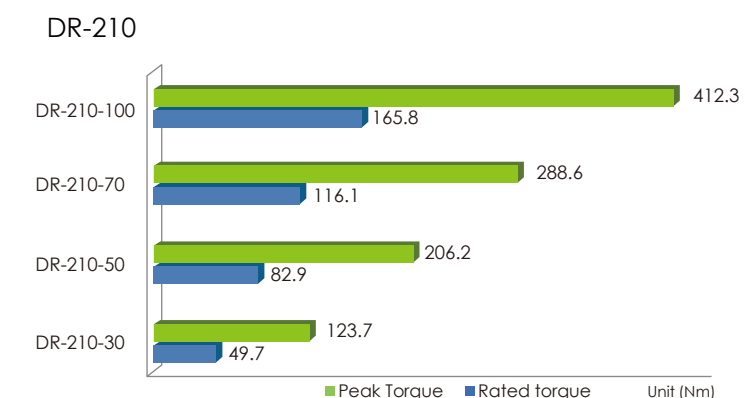
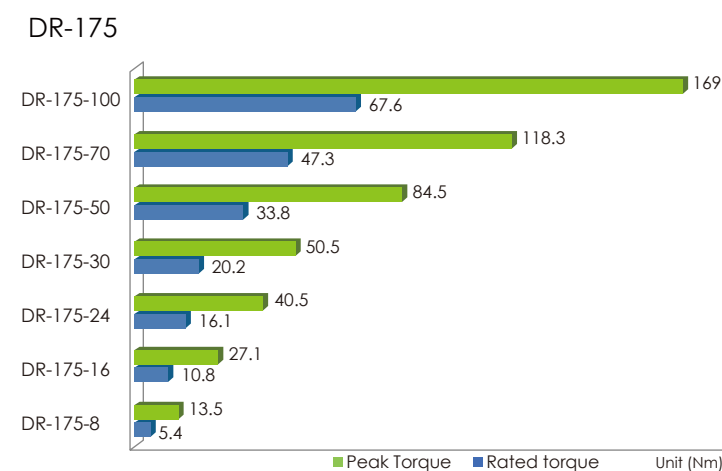
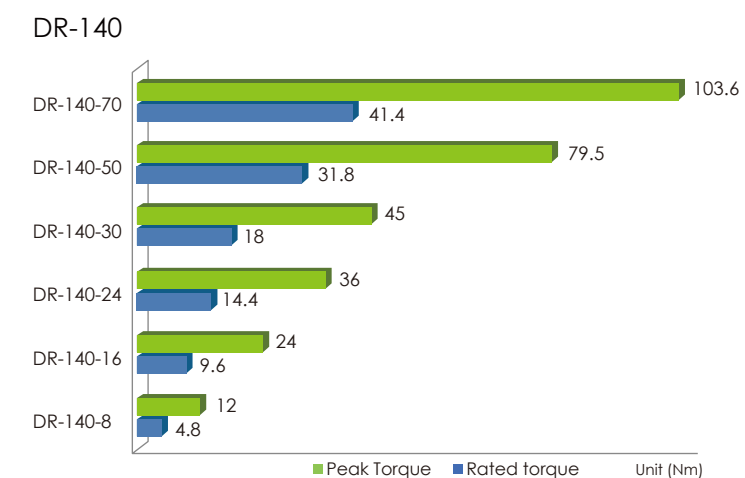
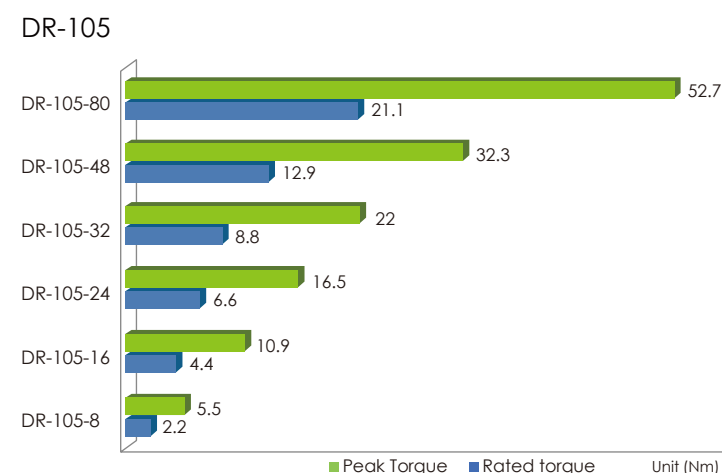
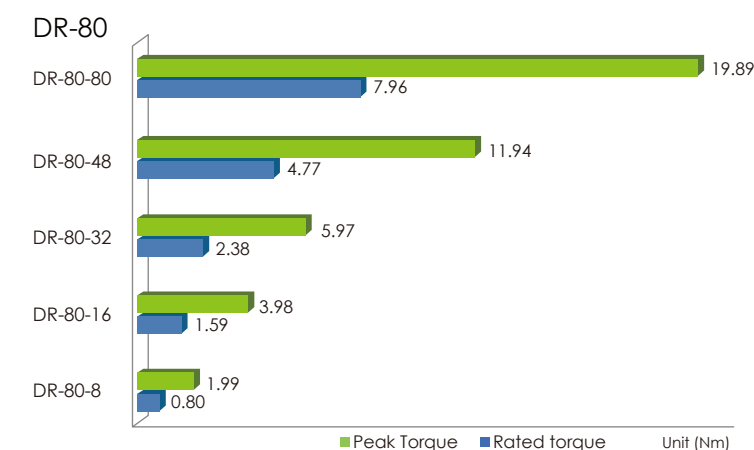
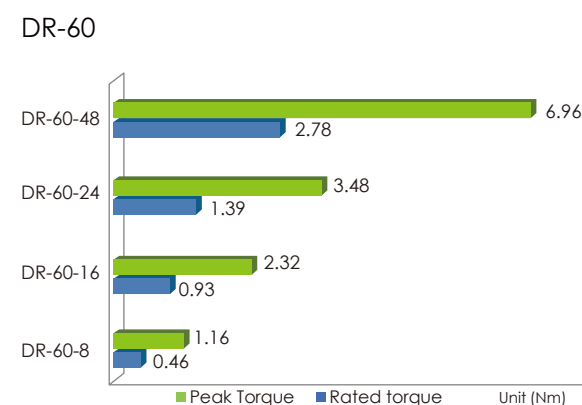
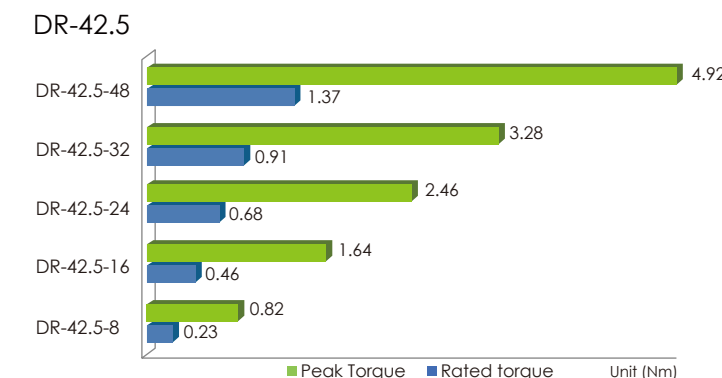
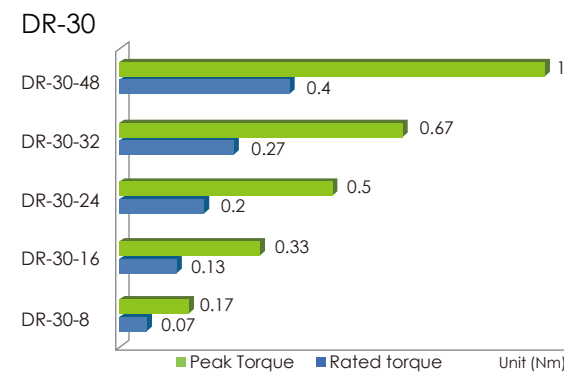

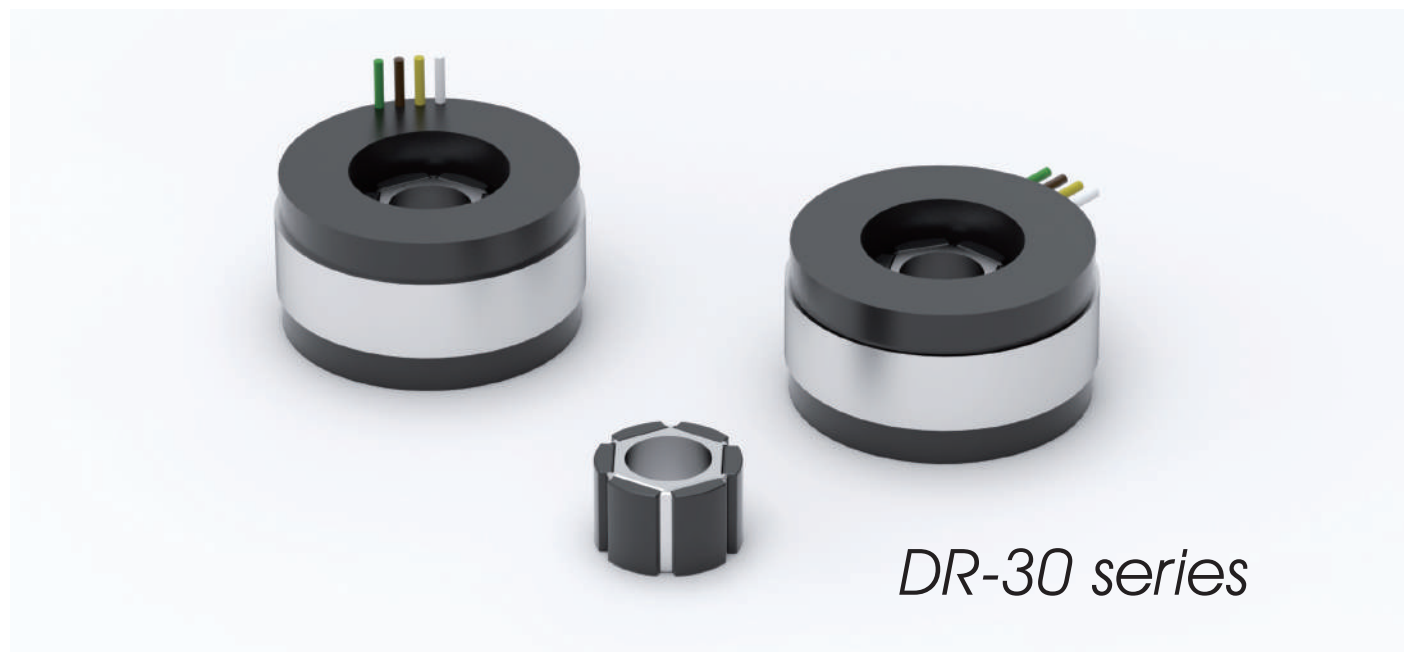

DR-30 series

DR-30

	Unit	cpc				
3-phase synchronous frameless Torque						
Coil assembly model		DR-30-8	DR-30-16	DR-30-24	DR-30-32	DR-30-48
Peak torque ⁽²⁾⁽³⁾	Nm	0.17	0.33	0.5	0.67	1
Continuous torque with heat sink ⁽¹⁾⁽²⁾	Nm	0.07	0.13	0.2	0.27	0.4
Continuous torque without heat sink ⁽²⁾⁽³⁾	Nm	0.03	0.05	0.08	0.11	0.16
Maximum speed	rpm	25208 @DC 48V	12604 @DC 48V	10503 @DC 60V	9453 @AC72V	8402 @AC96V
Stator OD	mm	30				
Rotor ID	mm	8.1				
Lamination stack height	mm	8	16	24	32	48
Rotor inertia	kg*m ²	1.8×10 ⁻⁸	4.3×10 ⁻⁸	1.1×10 ⁻⁷	2.3×10 ⁻⁷	7×10 ⁻⁷
Stator mass	kg	0.04	0.07	0.10	0.12	0.18
Rotor mass	kg	0.01	0.01	0.02	0.02	0.04
Total mass	kg	0.05	0.08	0.12	0.14	0.22
Electrical						
Peak current ⁽²⁾⁽³⁾	A _{pk}	7.5	7.5	7.5	7.5	7.5
Continuous current with heat sink ⁽¹⁾⁽²⁾	A _{pk}	3	3	3	3	3
Continuous current without heat sink ⁽²⁾⁽³⁾	A _{pk}	1.2	1.2	1.2	1.2	1.2
Max. current (Linear range) ⁽²⁾	A _{pk}	3.5	3.5	3.5	3.5	3.5
Motor torque constant	Nm/A _{pk}	0.022	0.045	0.067	0.089	0.134
Back EMF constant ⁽²⁾	V/rad/s	0.026	0.051	0.077	0.103	0.154
Resistance	Ω	2.88	4.41	5.93	7.45	10.48
Inductance	mH	2.02	3.09	4.15	5.22	7.34
Time constant ⁽²⁾	ms	0.7	0.7	0.7	0.7	0.7
Thermal resistance without heat sink ⁽²⁾⁽³⁾	°C/W	17.3	11.2	8.4	6.7	4.7
Thermal resistance with heat sink ⁽¹⁾⁽²⁾	°C/W	3.2	2.05	1.4	1.15	0.83
Motor constant ⁽²⁾	N/√W	0.01	0.02	0.03	0.03	0.04
Magnet poles	N(2τ)	6				
Rated voltage	V	48V _{dc}		72V _{dc}		96V _{dc}
Ph-PE dielectric strength		≥ 500V(AC)		≥ 1100V(AC)		≥ 1150V(AC)
Ph-PE insulation resistance		≥ 700V(DC)		≥ 1200V(DC)		≥ 1700V(DC)

(1) This value applies to the static sinusoidal drive under specific heat sink and temperature ranges from 25°C up to 110°C. The actual performance is dependent on the heat sink configuration, system cooling condition and ambient temperature.

(2) The tolerance levels for the total performance and electrical specification is ±10%

(3) This value applies to static sinusoidal drive operating under temperatures from 25°C up to 110°C, without heat sink.

(4) The above "without heat sink" figure assumes a working condition of 1 atm, 25°C ambient temperature, in which the linear motor is stationary and not in contact with any other objects, relying only on free air convection for cooling. As all heat conductive objects in direct contact with the motor, including the plate, bearing and housing, can be considered a kind of heat sink, the "with heat sink" figure should be taken as the primary reference in actual application design.

Torque / Speed Curve

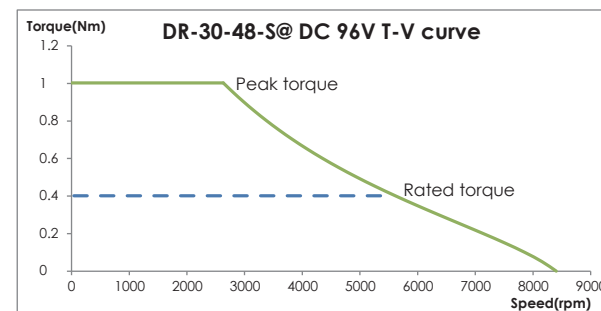
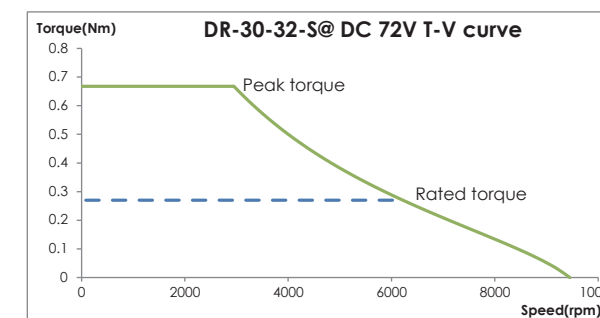
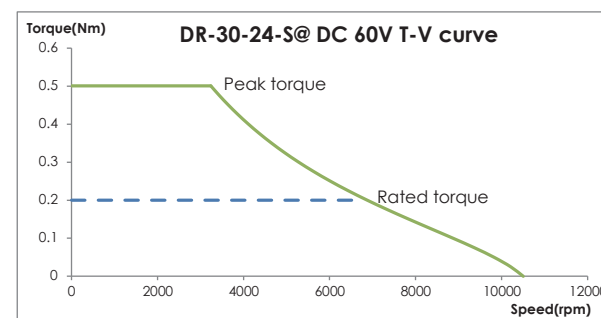
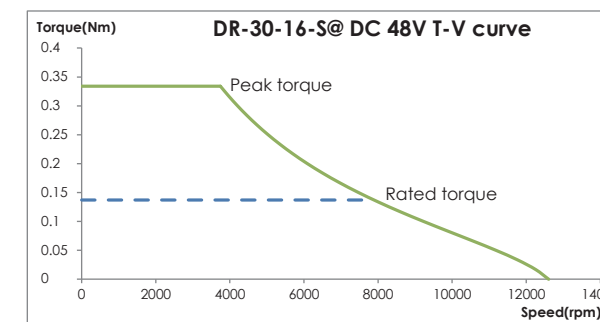
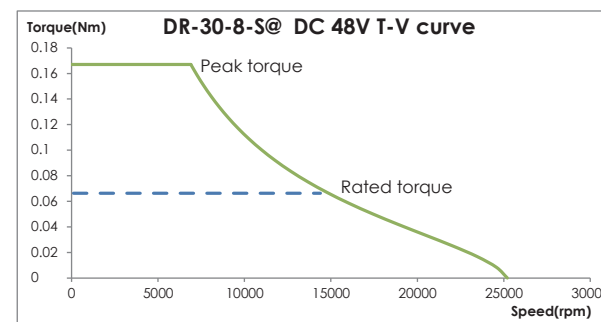

Dimension

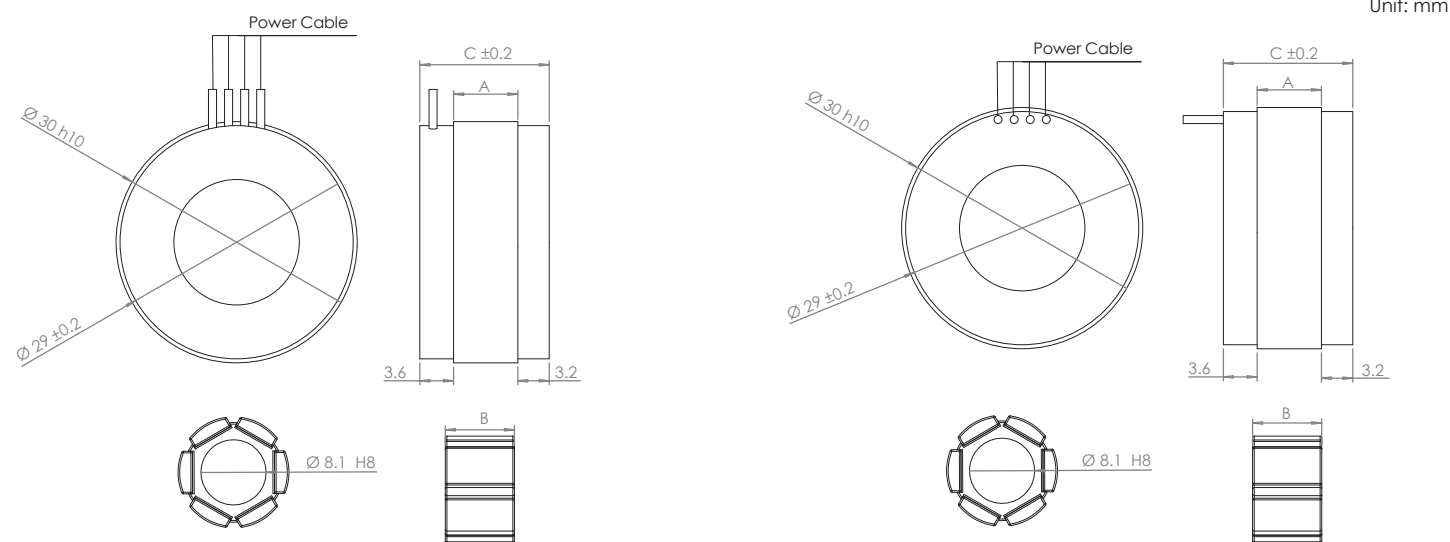

Unit: mm

OUTPUT CABLE

(All cable standard length is 400 mm)

Motor Wire Table		
Pin Number	Function	Cross section
White	U phase	0.89 mm ²
Yellow	V phase	0.89 mm ²
Brown	W phase	0.89 mm ²
Green	PE + shielding	0.89 mm ²

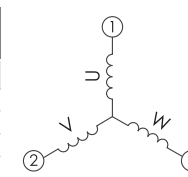

DIMENSIONS

Type	A	B	C
DR-30-8	8	8.6	14.8
DR-30-16	16	16.6	22.8
DR-30-24	24	24.6	30.8
DR-30-32	32	32.6	38.8
DR-30-48	48	48.6	54.8



Torque / Speed Curve

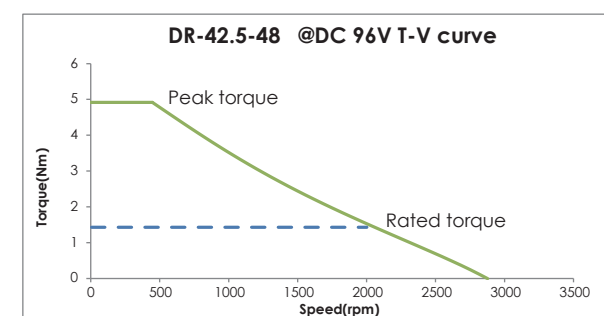
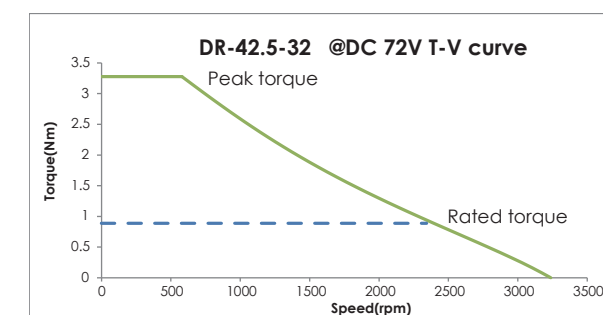
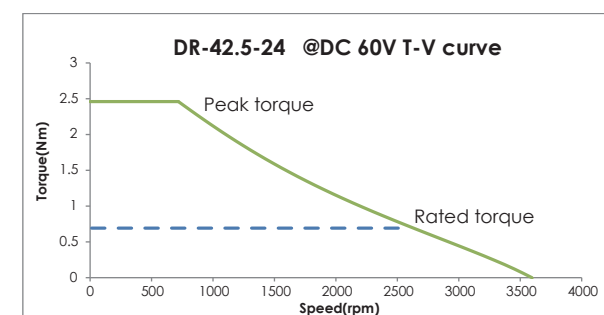
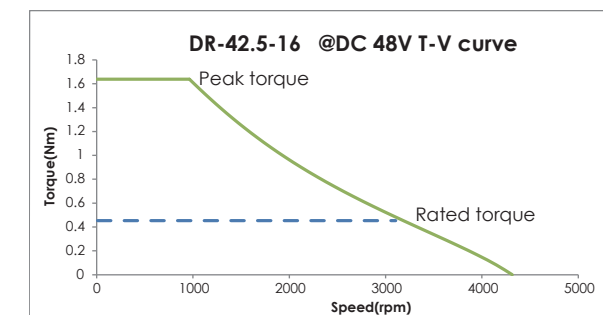
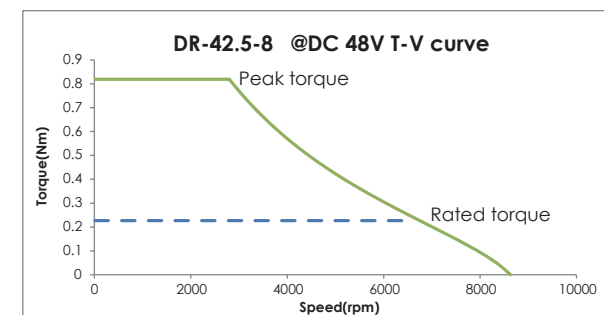

DR-42.5

	Unit	cpc				
3-phase synchronous frameless Torque						
Coil assembly model		DR-42.5-8	DR-42.5-16	DR-42.5-24	DR-42.5-32	DR-42.5-48
Performance						
Peak torque ⁽²⁾⁽³⁾	Nm	0.82	1.64	2.46	3.28	4.92
Continuous torque with heat sink ⁽¹⁾⁽²⁾	Nm	0.23	0.46	0.68	0.91	1.37
Continuous torque without heat sink ⁽²⁾⁽³⁾	Nm	0.08	0.17	0.25	0.34	0.51
Maximum speed	rpm	8631 @ DC48V	4315 @ DC48V	3596 @ DC60V	3236 @ DC72V	2877 @ DC96V
Mechanical						
Stator OD	mm	42.5				
Rotor ID	mm	27				
Lamination stack height	mm	8	16	24	32	48
Rotor inertia	kg*m ²	1.7×10 ⁻⁷	3.4×10 ⁻⁷	5.1×10 ⁻⁷	6.8×10 ⁻⁷	1.48×10 ⁻⁶
Stator mass	kg	0.05	0.08	0.11	0.14	0.2
Rotor mass	kg	0.01	0.02	0.03	0.04	0.06
Total mass	kg	0.06	0.1	0.14	0.18	0.26
Electrical						
Peak current ⁽²⁾⁽³⁾	A _{pk}	12.6	12.6	12.6	12.6	12.6
Continuous current with heat sink ⁽¹⁾⁽²⁾	A _{pk}	3.5	3.5	3.5	3.5	3.5
Continuous current without heat sink ⁽²⁾⁽³⁾	A _{pk}	1.3	1.3	1.3	1.3	1.3
Motor torque constant	Nm/A _{pk}	0.065	0.13	0.195	0.26	0.39
Back EMF constant ⁽²⁾	V/rad/s	0.075	0.15	0.225	0.3	0.451
Resistance	Ω	2.8	4.3	5.8	7.3	10.2
Inductance	mH	0.81	1.25	1.68	2.12	2.96
Time constant ⁽²⁾	ms	0.29	0.29	0.29	0.29	0.29
Thermal resistance without heat sink ⁽²⁾⁽³⁾	°C/W	18	12	8.8	7	5
Thermal resistance with heat sink ⁽¹⁾⁽²⁾	°C/W	2.5	1.6	1.2	0.96	0.69
Motor constant ⁽²⁾	N/√W	0.04	0.06	0.08	0.64	0.12
Magnet poles	N(2τ)	20				
Rated voltage	V	48V _{dc}		72V _{dc}		96V _{dc}
Ph-PE dielectric strength		≥ 500V(AC)		≥ 1100V(AC)		≥ 1150V(AC)
Ph-PE insulation resistance		≥ 700V(DC)		≥ 1200V(DC)		≥ 1700V(DC)

- (1) This value applies to the static sinusoidal drive under specific heat sink and temperature ranges from 25°C up to 110°C. The actual performance is dependent on the heat sink configuration, system cooling condition and ambient temperature.
- (2) The tolerance levels for the total performance and electrical specification is ±10%
- (3) This value applies to static sinusoidal drive operating under temperatures from 25°C up to 110°C, without heat sink.
- (4) The above "without heat sink" figure assumes a working condition of 1 atm, 25°C ambient temperature, in which the linear motor is stationary and not in contact with any other objects, relying only on free air convection for cooling. As all heat conductive objects in direct contact with the motor, including the plate, bearing and housing, can be considered a kind of heat sink, the "with heat sink" figure should be taken as the primary reference in actual application design.

Dimension

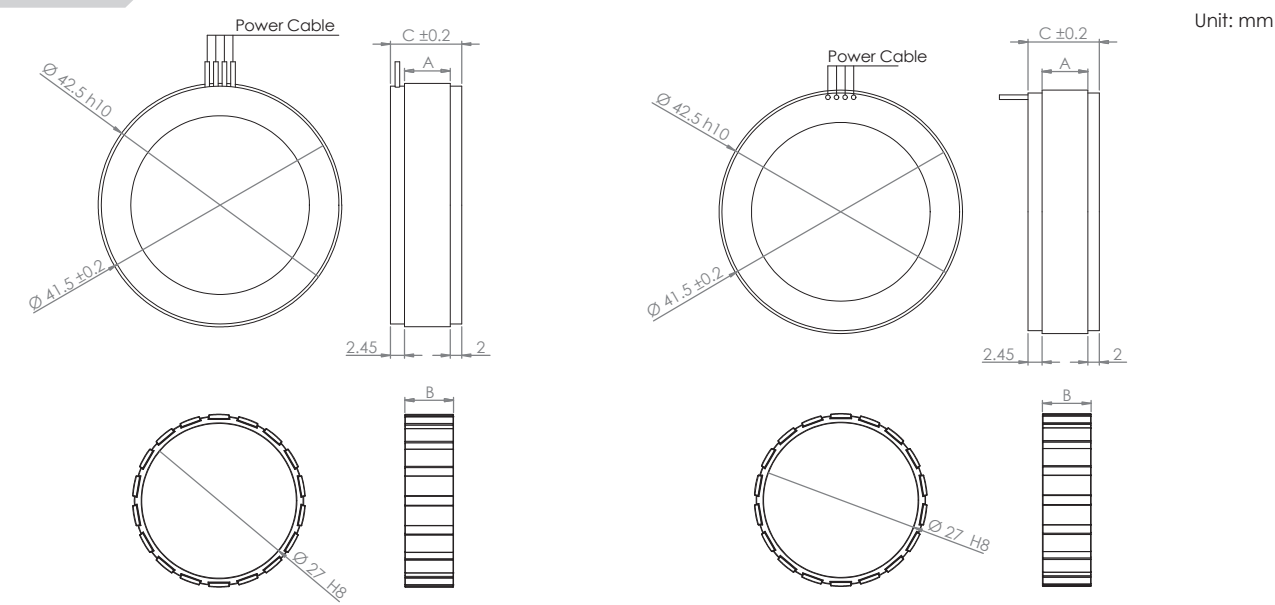

OUTPUT CABLE

(All cable standard length is 400 mm)

Motor Wire Table		
Pin Number	Function	Cross section
White	U phase	0.89 mm ²
Yellow	V phase	0.89 mm ²
Brown	W phase	0.89 mm ²
Green	PE + shielding	0.89 mm ²

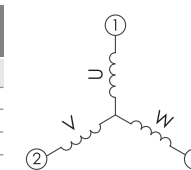

DIMENSIONS

Type	A	B	C
DR-42.5-8	8	8.6	12.5
DR-42.5-16	16	16.6	20.5
DR-42.5-24	24	24.6	28.5
DR-42.5-32	32	32.2	36.5
DR-42.5-48	48	48.8	52.5

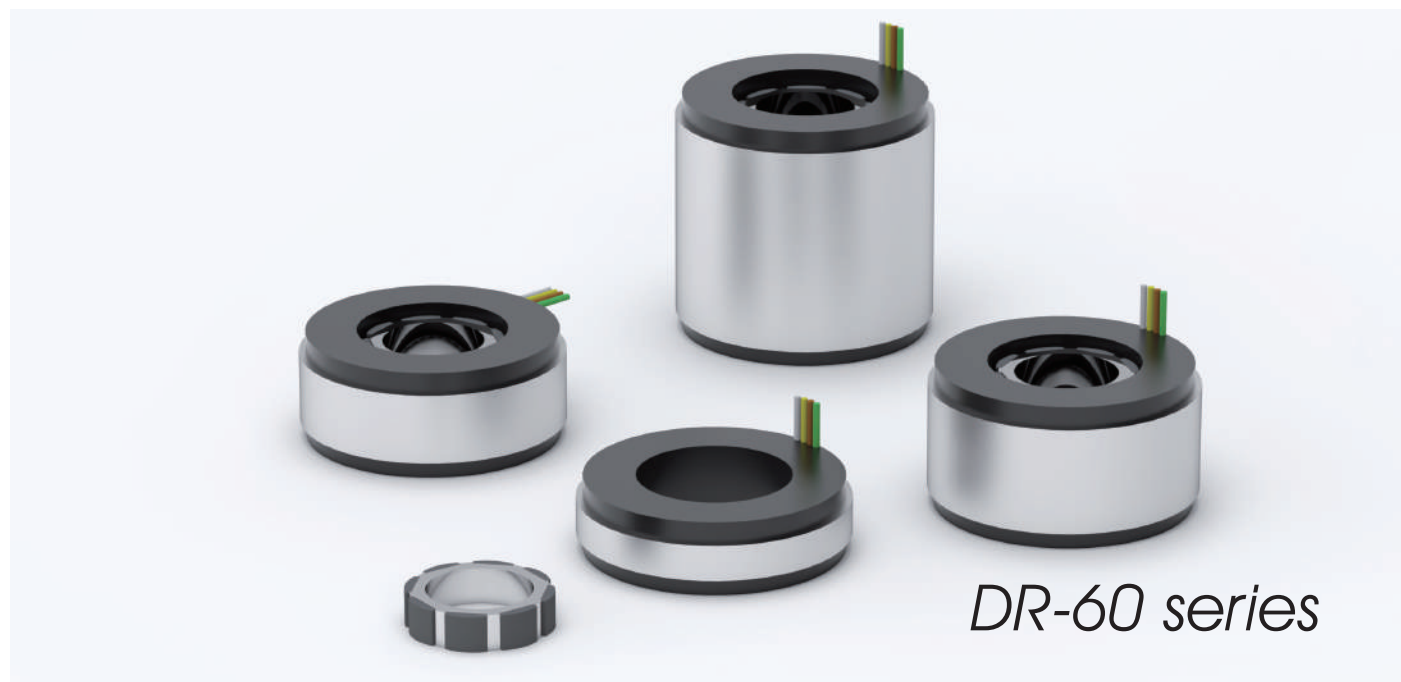

DR-60 series

DR-60

	Unit	cpc			
3-phase synchronous frameless Torque					
Coil assembly model		DR-60-8	DR-60-16	DR-60-24	DR-60-48
Performance					
Peak torque ⁽²⁾⁽³⁾	Nm	1.16	2.32	3.48	6.96
Continuous torque with heat sink	Nm	0.46	0.93	1.39	2.78
Continuous torque without heat sink	Nm	0.19	0.38	0.57	1.14
Maximum speed @DC 48V	rpm	10894	5447	3631	1815
Mechanical					
Stator OD	mm	60			
Rotor ID	mm	23			
Lamination stack height	mm	8	16	24	48
Rotor inertia	kg*m ²	2.52×10 ⁻⁶	5.67×10 ⁻⁶	1.03×10 ⁻⁵	4.1×10 ⁻⁵
Stator mass	kg	0.15	0.25	0.36	0.68
Rotor mass	kg	0.02	0.05	0.07	0.14
Total mass	kg	0.17	0.3	0.43	0.81
Electrical					
Peak current ⁽²⁾⁽³⁾	A _{pk}	22.5	22.5	22.5	22.5
Continuous current with heat sink	A _{pk}	9	9	9	9
Continuous current without heat sink	A _{pk}	3.7	3.7	3.7	3.7
Max. current (Linear range) ⁽²⁾	A _{pk}	15	15	15	15
Motor torque constant	Nm/A _{pk}	0.052	0.103	0.155	0.309
Back EMF constant ⁽²⁾	V/rad/s	0.06	0.119	0.179	0.357
Resistance	Ω	0.57	0.79	1.02	1.68
Inductance	mH	1.52	2.11	2.7	4.48
Time constant ⁽²⁾	ms	2.7	2.7	2.7	2.7
Thermal resistance without heat sink ⁽²⁾⁽³⁾	°C/W	10.5	9.1	7.1	4.2
Thermal resistance with heat sink ⁽¹⁾⁽²⁾	°C/W	1.9	1.6	1.2	0.72
Motor constant ⁽²⁾	N/√W	0.07	0.12	0.15	0.24
Magnet poles	N(2τ)	8			
Rated voltage	V	48V _{dc}			
Ph-PE dielectric strength		≥ 500V(AC)			
Ph-PE insulation resistance		≥ 600V(DC)			

- (1) This value applies to the static sinusoidal drive under specific heat sink and temperature ranges from 25°C up to 110°C. The actual performance is dependent on the heat sink configuration, system cooling condition and ambient temperature.
- (2) The tolerance levels for the total performance and electrical specification is ±10%
- (3) This value applies to static sinusoidal drive operating under temperatures from 25°C up to 110°C, without heat sink.
- (4) The above "without heat sink" figure assumes a working condition of 1 atm, 25°C ambient temperature, in which the linear motor is stationary and not in contact with any other objects, relying only on free air convection for cooling. As all heat conductive objects in direct contact with the motor, including the plate, bearing and housing, can be considered a kind of heat sink, the "with heat sink" figure should be taken as the primary reference in actual application design.

Torque / Speed Curve

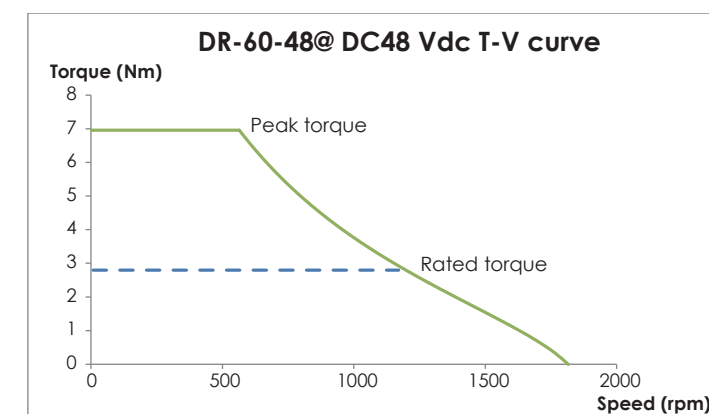
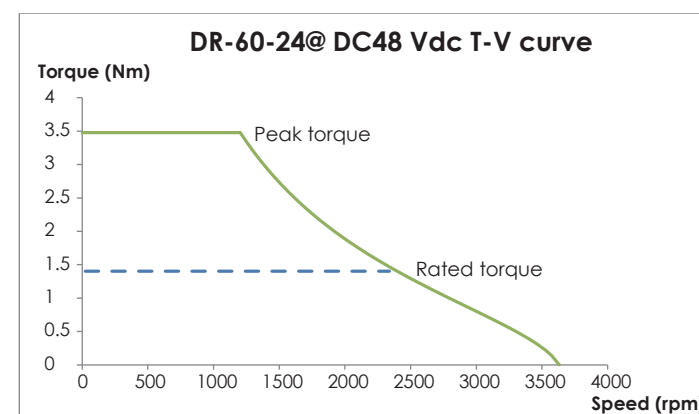
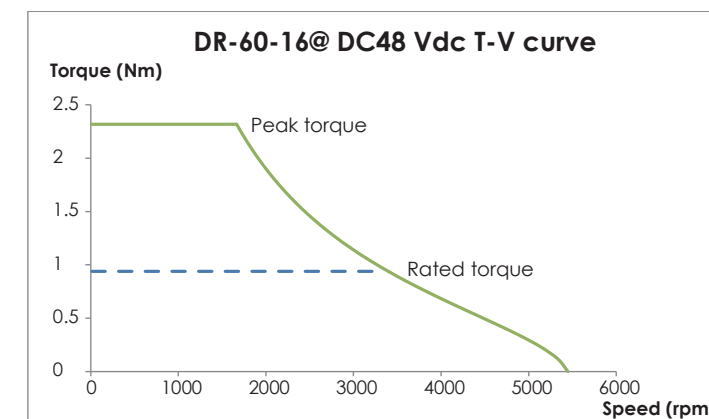
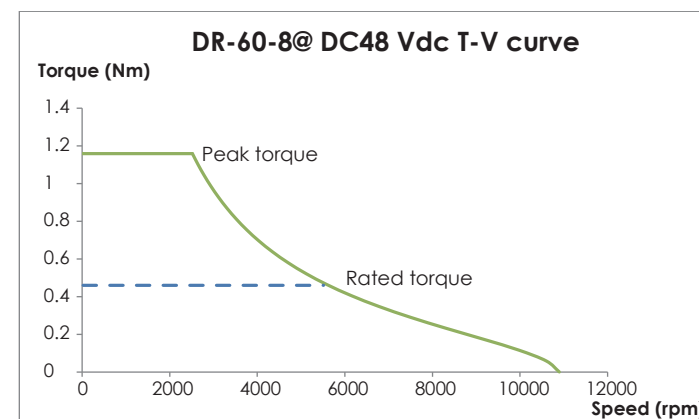

Dimension

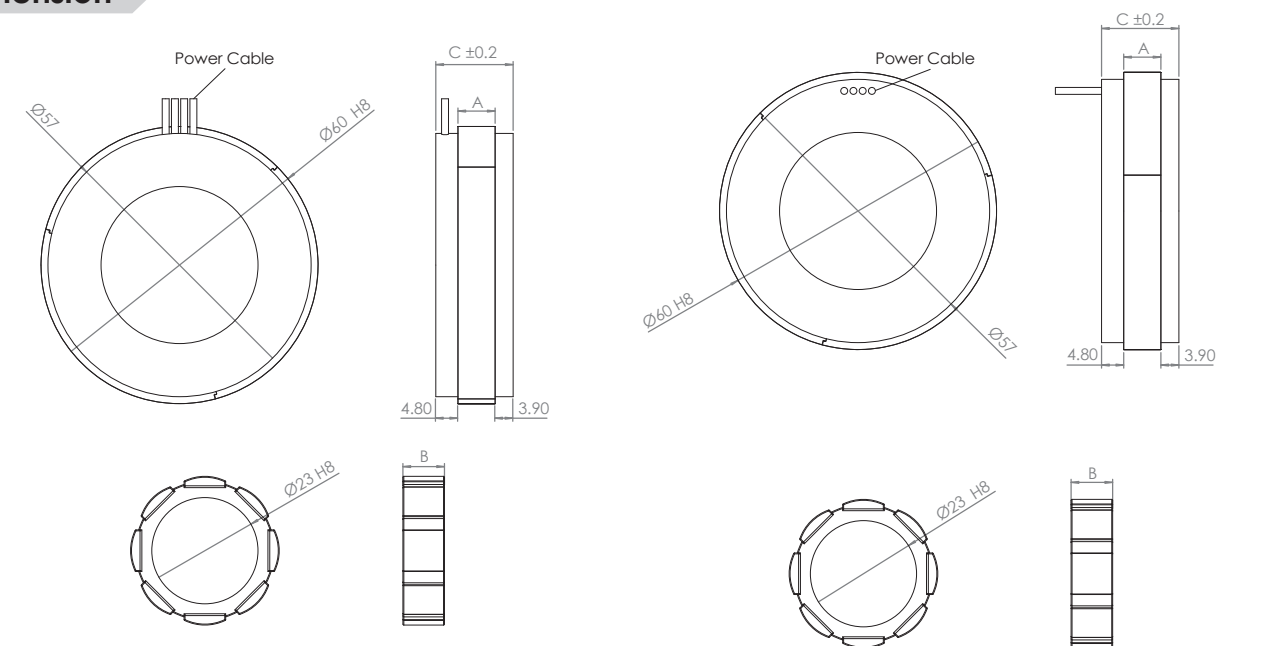

OUTPUT CABLE

(All cable standard length is 400 mm)

Motor Wire Table		
Pin Number	Function	Cross section
White	U phase	0.89 mm ²
Yellow	V phase	0.89 mm ²
Brown	W phase	0.89 mm ²
Green	PE + shielding	0.89 mm ²

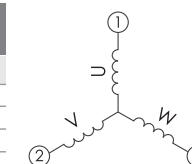

DIMENSIONS

Type	A	B	C
DR-60-8	8	8.6	16.7
DR-60-16	16	16.6	24.7
DR-60-24	24	24.6	32.7
DR-60-48	48	48.6	56.7

Unit: mm

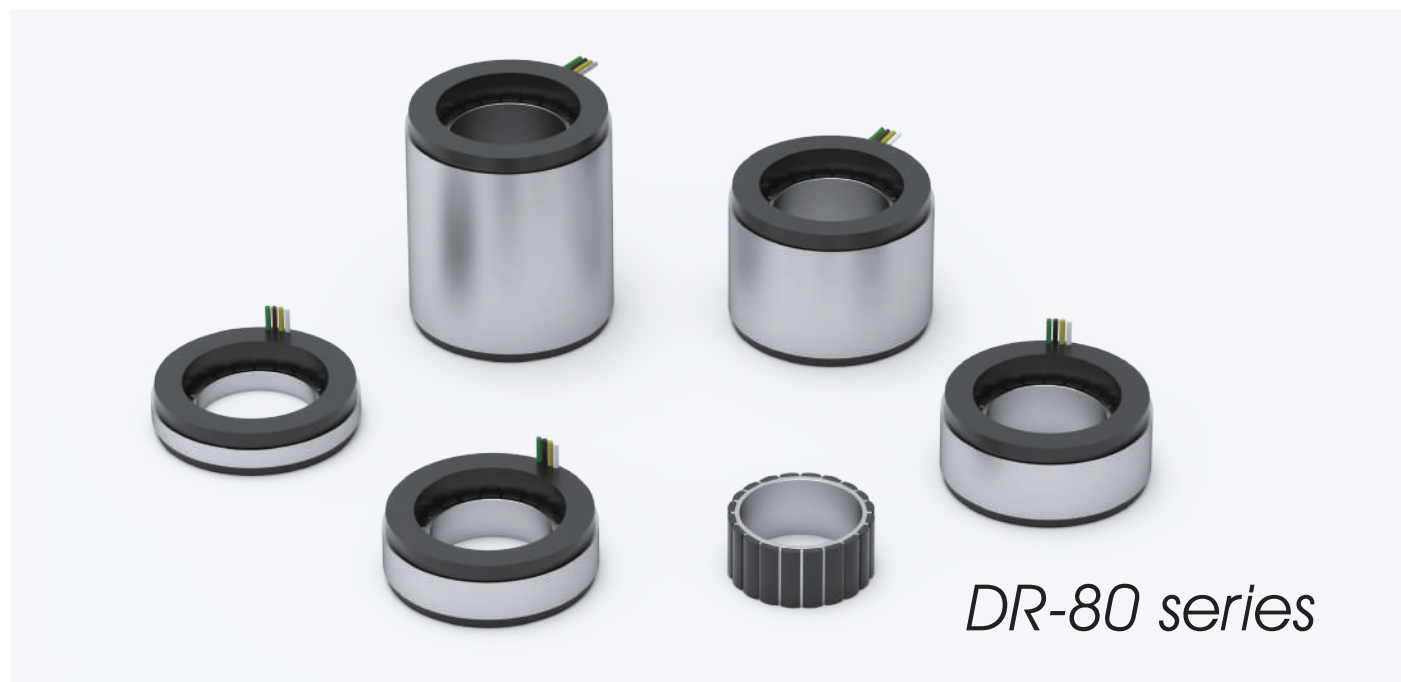

DR-80

	Unit	cpc											
		3-phase synchronous frameless Torque											
Coil assembly model		DR-80-8		DR-80-16		DR-80-24		DR-80-48		DR-80-80			
Winding code		S	D	S	D	S	D	S	D	S	D		
Performance													
Peak torque ⁽²⁾⁽³⁾	Nm	1.99		3.98		5.97		11.94		19.89			
Continuous torque with heat sink	Nm	0.8		1.59		2.38		4.77		7.96			
Continuous torque without heat sink	Nm	0.33		0.65		0.98		1.96		3.28			
Maximum speed AC 230V@DC 325V	rpm	3139	6279	1569	3139	1046	2093	523	1064	313	627		
Mechanical													
Stator OD	mm	80											
Rotor ID	mm	45											
Lamination stack height	mm	8		16		24		48		80			
Rotor inertia	kg*m ²	2.8*10 ⁻⁵		5.4*10 ⁻⁵		8.1*10 ⁻⁵		1.6*10 ⁻⁴		3.7*10 ⁻⁴			
Stator mass	kg	0.25		0.4		0.55		1		1.6			
Rotor mass	kg	0.04		0.09		0.13		0.26		0.43			
Total mass	kg	0.29		0.49		0.68		1.26		2.03			
Electrical													
Peak current ⁽²⁾⁽³⁾	A _{pk}	16	32	16	32	16	32	16	32	16	32		
Continuous current with heat sink ⁽¹⁾⁽²⁾	A _{pk}	6.4	12.8	6.4	12.8	6.4	12.8	6.4	12.8	6.4	12.8		
Continuous current without heat sink ⁽²⁾⁽³⁾	A _{pk}	2.6	5.3	2.6	5.3	2.6	5.3	2.6	5.3	2.6	5.3		
Motor torque constant	Nm/A _{pk}	0.12	0.06	0.25	0.12	0.37	0.19	0.75	0.37	1.24	0.62		
Back EMF constant ⁽²⁾	V/rad/s	0.14	0.07	0.29	0.14	0.43	0.22	0.86	0.43	1.44	0.72		
Resistance ⁽²⁾	Ω	0.42	0.11	0.60	0.15	0.78	0.20	1.32	0.33	2.03	0.51		
Inductance	mH	1.24	0.31	1.77	0.44	2.30	0.58	3.89	0.97	5.99	1.50		
Time constant ⁽²⁾	ms	2.95	2.95	2.95	2.95	2.95	2.95	2.95	2.95	2.95	2.95		
Thermal resistance without heat sink ⁽²⁾⁽³⁾	°C/W	30.4		21.3		16.4		9.7		6.3			
Thermal resistance with heat sink ⁽¹⁾⁽²⁾	°C/W	5.03		3.52		2.7		1.6		1			
Motor constant ⁽²⁾	N/√W	0.19		0.32		0.42		0.65		0.87			
Rated voltage	N(2τ)	20											
Rated voltage	V	DC48V											
Ph-PE dielectric strength		≥ 500V(AC)											
Ph-PE insulation resistance		≥ 700V(DC)											

(1) This value applies to the static sinusoidal drive under specific heat sink and temperature ranges from 25°C up to 110°C. The actual performance is dependent on the heat sink configuration, system cooling condition and ambient temperature.

(2) The tolerance levels for the total performance and electrical specification is ±10%

(3) This value applies to static sinusoidal drive operating under temperatures from 25°C up to 110°C, without heat sink.

(4) The above "without heat sink" figure assumes a working condition of 1 atm, 25°C ambient temperature, in which the linear motor is stationary and not in contact with any other objects, relying only on free air convection for cooling. As all heat conductive objects in direct contact with the motor, including the plate, bearing and housing, can be considered a kind of heat sink, the "with heat sink" figure should be taken as the primary reference in actual application design.

Torque / Speed Curve

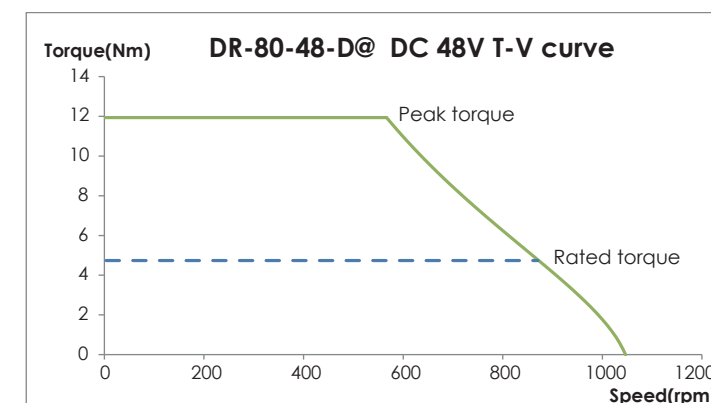
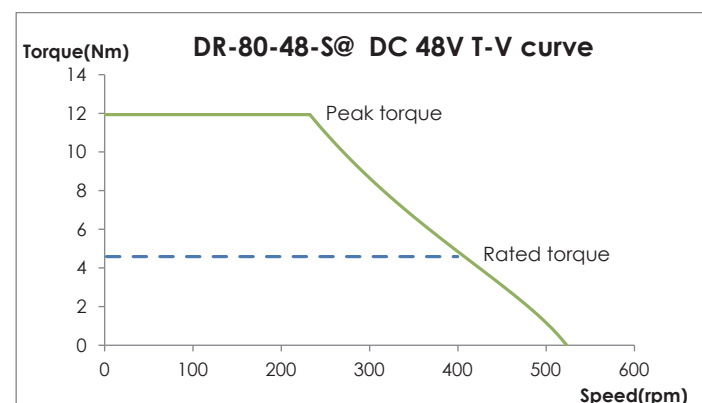
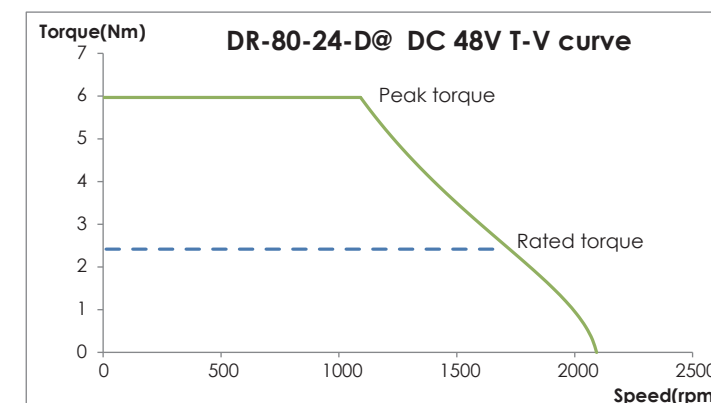
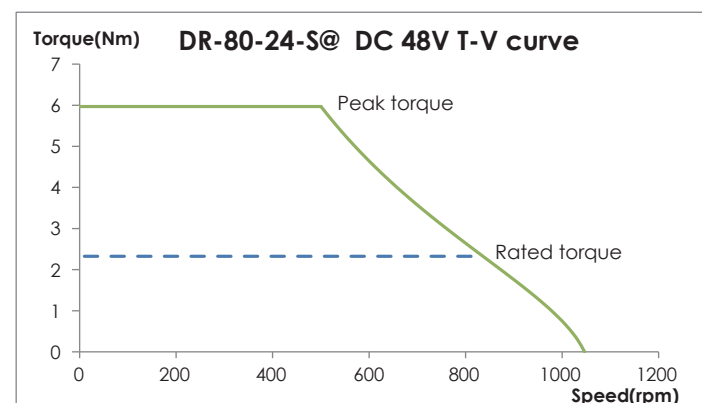
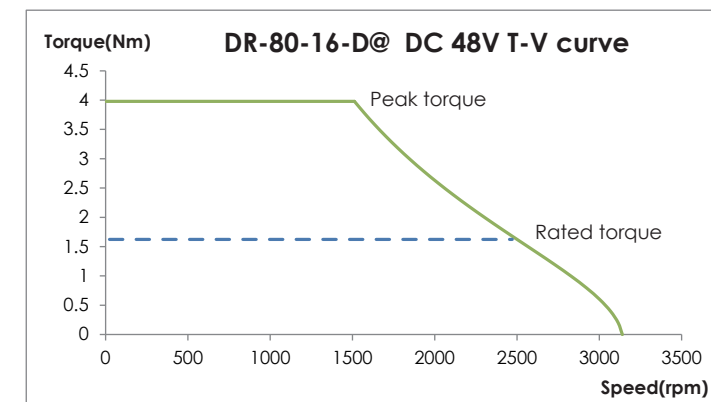
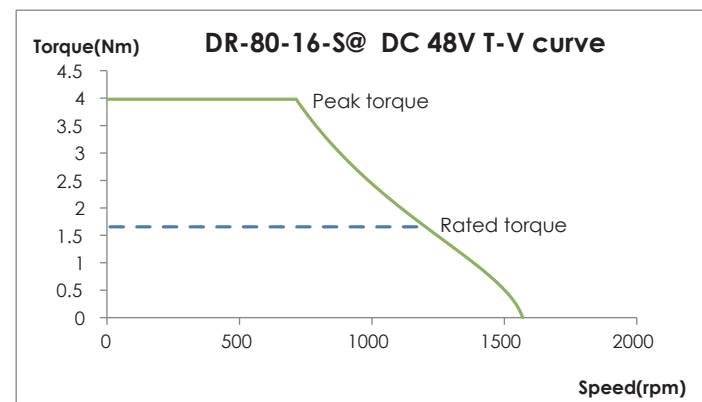
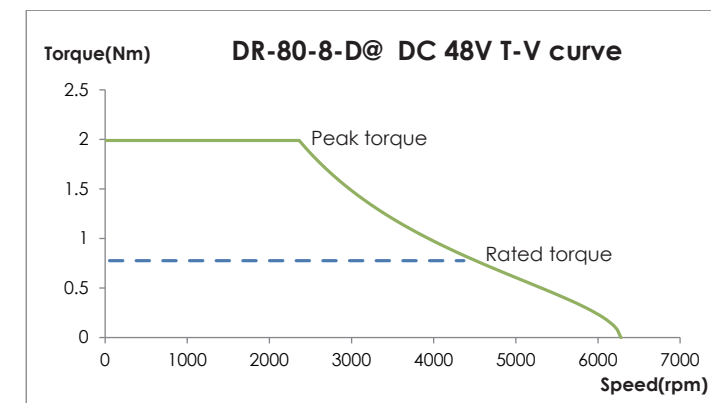
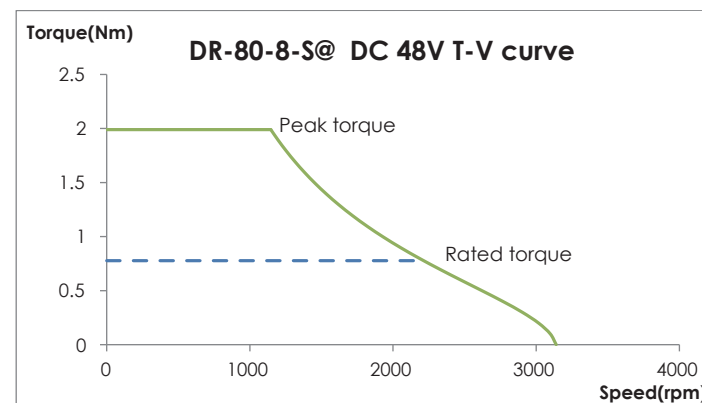

Torque / Speed Curve

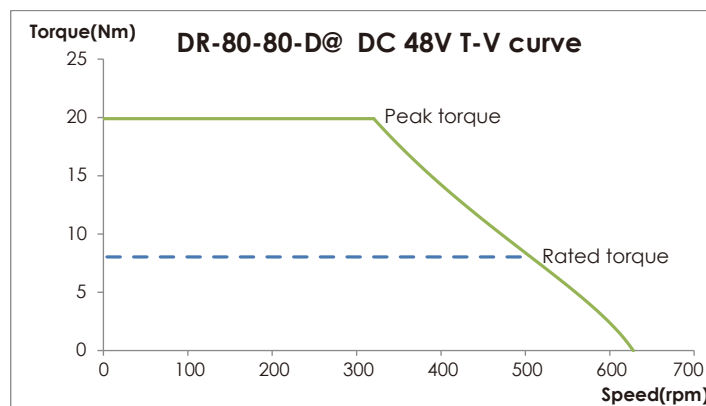
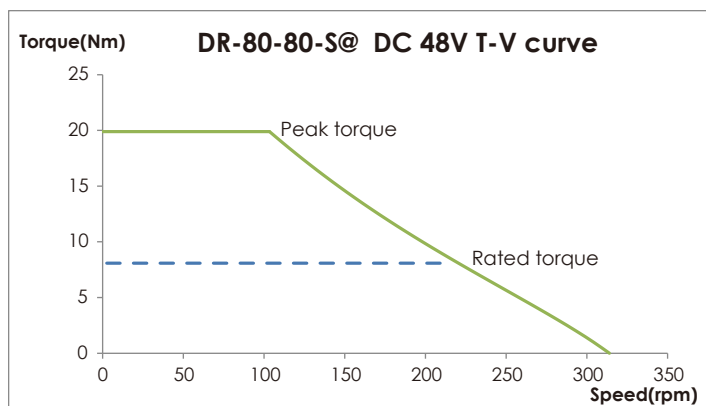

Dimension

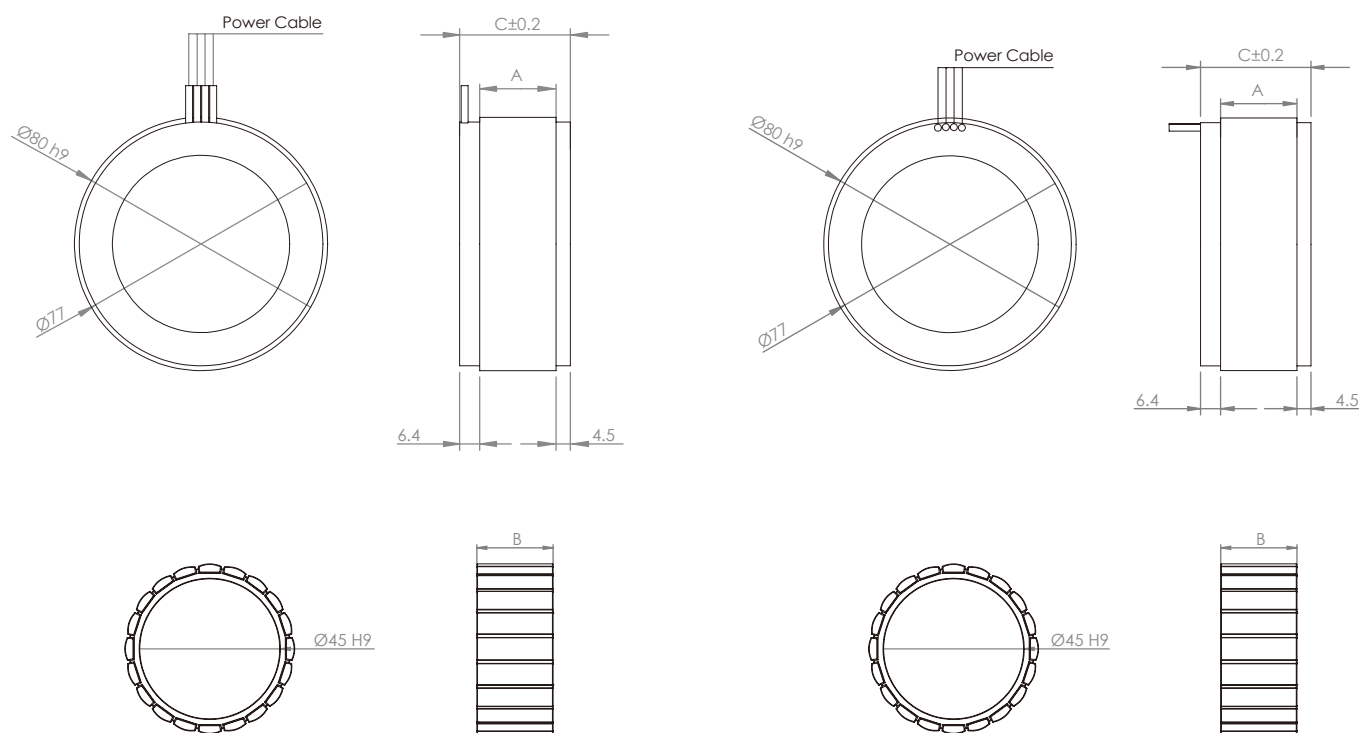

OUTPUT CABLE (All cable standard length is 400 mm)

Motor Wire Table			Hall Sensor Wire Table and Thermal Protection Wire Table					
Pin Number	Function	Cross section	Color	Function	Cable Dia.	Color	Function	Cable Dia.
White	U phase	0.5 mm ²	Pink	Hall A U phase	0.14 mm ²	Brown	Thermal sensor	0.14 mm ²
Yellow	V phase	0.5 mm ²	Yellow	Hall B V phase	0.14 mm ²	Blue		
Brown	W phase	0.5 mm ²	Green	Hall C W phase	0.14 mm ²		Shielding	
Green	PE + shielding	0.5 mm ²	Grey	Hall IC + 5V	0.14 mm ²			
			White	GND	0.14 mm ²			

DIMENSIONS

Type	A	B	C
DR-80-8	8	8.5	19
DR-80-16	16	16.5	27
DR-80-24	24	24.5	35
DR-80-48	48	48.5	59
DR-80-80	80	80.5	91

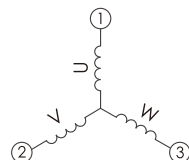

DR-105

	Unit	cpc											
3-phase synchronous frameless Torque. 230V _{ac rms} (325V _{dc})													
Coil assembly model		DR-105-8		DR-105-16		DR-105-24		DR-105-32		DR-105-48		DR-105-80	
Winding code		S	F	S	F	S	F	S	F	S	F	S	F
Performance													
Peak torque ⁽²⁾⁽³⁾	Nm	5.5	10.9	16.5	22	32.3	52.7						
Continuous torque with heat sink ⁽¹⁾⁽²⁾	Nm	2.2	4.4	6.6	8.8	12.9	21.1						
Continuous torque without heat sink ⁽²⁾⁽³⁾	Nm	1.1	2.2	3.4	4.3	6.5	10.3						
Maximum speed AC 230V@DC 325V	rpm	8778	2926	4433	1468	2945	977	2205	732	1472	488	883	293
Mechanical													
Stator OD	mm	105											
Rotor ID	mm	56											
Lamination stack height	mm	8	16	24	32	48	80						
Rotor inertia	kg*m ²	5.8*10 ⁻⁵	1.2*10 ⁻⁴	1.7*10 ⁻⁴	2.3*10 ⁻⁴	3.5*10 ⁻⁴	5.8*10 ⁻⁴						
Stator mass	kg	0.6	0.8	1.03	1.33	1.8	2.95						
Rotor mass	kg	0.06	0.12	0.19	0.25	0.37	0.62						
Total mass	kg	0.57	1.04	1.61	2.18	3.32	5.6						
Electrical													
Peak current ⁽²⁾⁽³⁾	A _{pk}	12.8	4.3	12.8	4.3	12.8	4.3	12.8	4	12.5	4	12.3	3.8
Continuous current with heat sink ⁽¹⁾⁽²⁾	A _{pk}	5.1	1.7	5.1	1.7	5.1	1.7	5.1	1.6	5	1.6	4.9	1.5
Continuous current without heat sink ⁽²⁾⁽³⁾	A _{pk}	2.6	0.8	2.6	0.8	2.6	0.8	2.5	0.7	2.5	0.7	2.4	0.6
Max. current (Linear range) ⁽²⁾	A _{pk}	5.5	1.9	5.5	1.9	5.5	1.9	5.5	1.9	5.4	1.8	5.4	1.8
Motor torque constant	Nm/A _{pk}	0.43	1.3	0.86	2.59	1.29	3.89	1.72	5.19	2.58	7.78	4.3	12.96
Back EMF constant ⁽²⁾	V/rad/s	0.5	1.5	0.99	2.99	1.49	4.49	1.99	5.99	2.98	8.98	4.97	14.97
Resistance	Ω	2.8	24.8	3.7	32.2	4.6	39.6	5.4	47	7.3	61.8	10.9	91.4
Inductance	mH	16.5	132.5	29.2	229.3	41.9	326.1	49.3	422.9	80	616.5	130.8	1003.7
Time constant ⁽²⁾	ms	5.9	5.3	7.9	7.1	9.1	8.2	9.1	9	11	10	12	11
Thermal resistance without heat sink ⁽²⁾⁽³⁾	°C/W	4.8		3.66		2.96		2.72		2.07		1.5	
Thermal resistance with heat sink ⁽¹⁾⁽²⁾	°C/W	1.19		0.83		0.67		0.59		0.44		0.31	
Motor constant ⁽²⁾	N/√W	0.26		0.45		0.6		0.74		0.96		1.3	
Magnet poles	N(2τ)	20											
Rated voltage	V	325V _{dc} / 230V _{ac}											
Ph-PE dielectric strength		≥ 1500V(AC)											
Ph-PE insulation Resistance		≥ 2350V(DC)											

- (1) This value applies to the static sinusoidal drive under specific heat sink and temperature ranges from 25°C up to 110°C. The actual performance is dependent on the heat sink configuration, system cooling condition and ambient temperature.
- (2) The tolerance levels for the total performance and electrical specification is ±10%.
- (3) This value applies to static sinusoidal drive operating under temperatures from 25°C up to 110°C, without heat sink.
- (4) The above "without heat sink" figure assumes a working condition of 1 atm, 25°C ambient temperature, in which the linear motor is stationary and not in contact with any other objects, relying only on free air convection for cooling. As all heat conductive objects in direct contact with the motor, including the plate, bearing and housing, can be considered a kind of heat sink, the "with heat sink" figure should be taken as the primary reference in actual application design.

Torque / Speed Curve

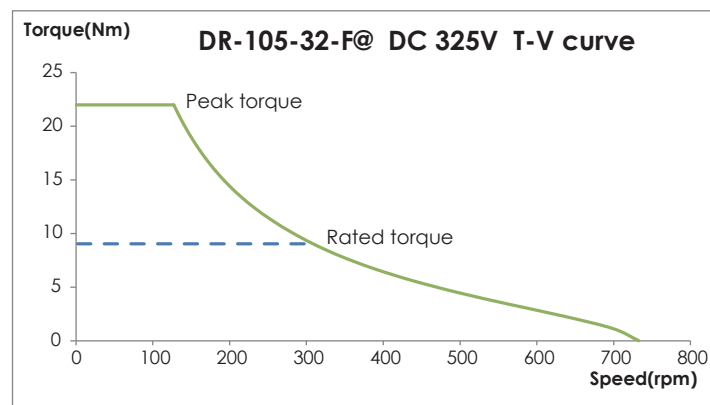
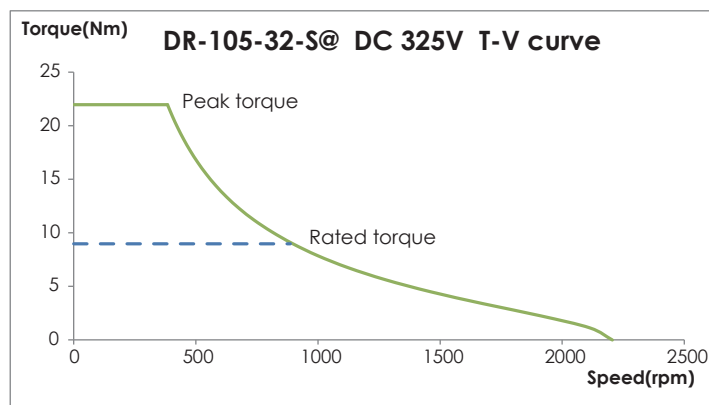
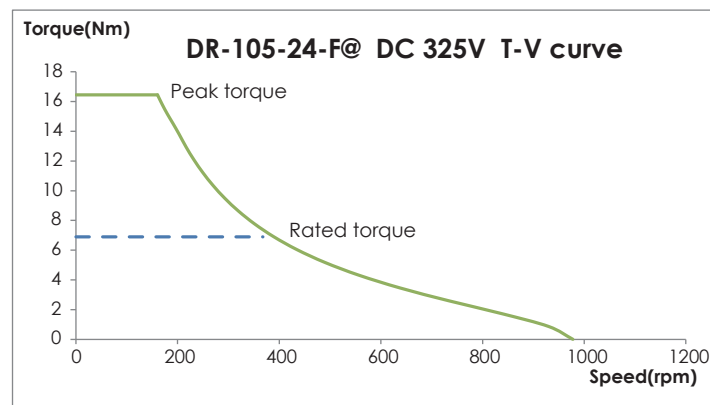
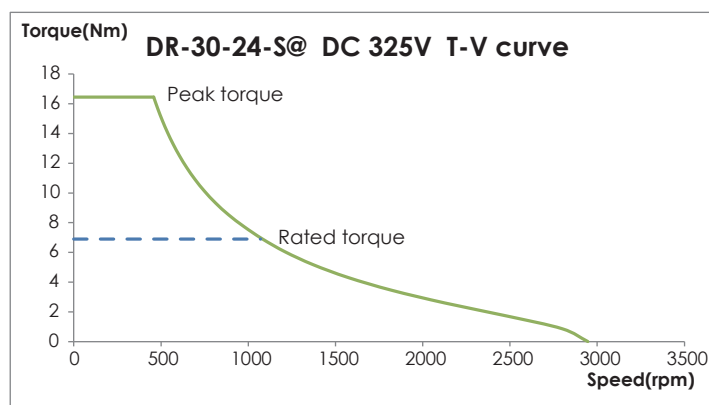
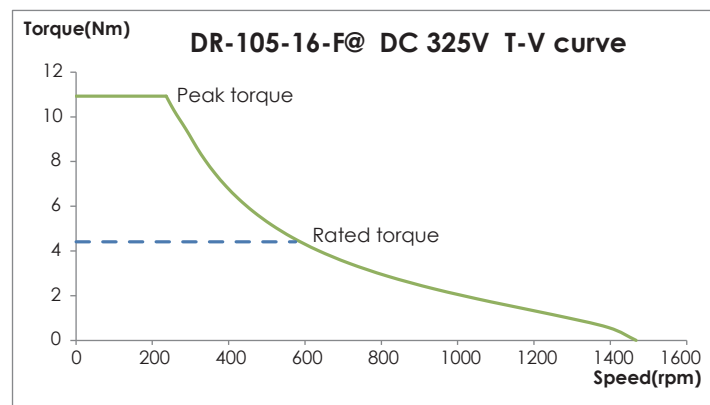
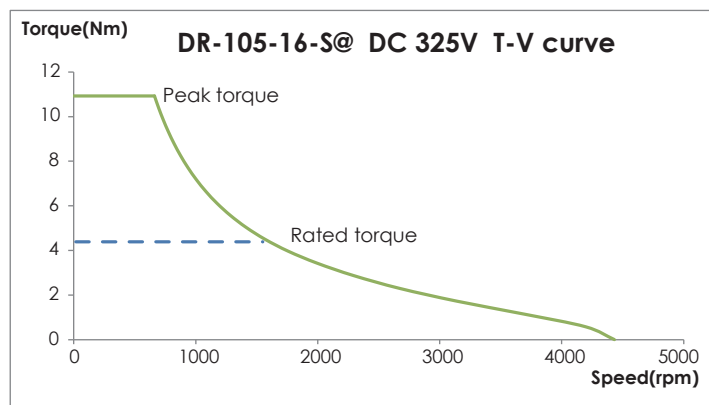
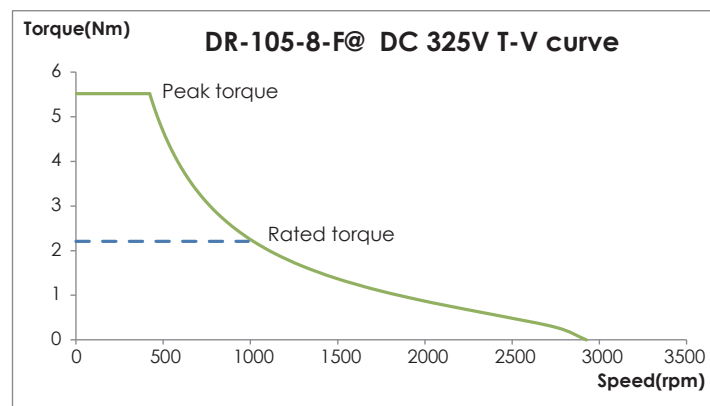
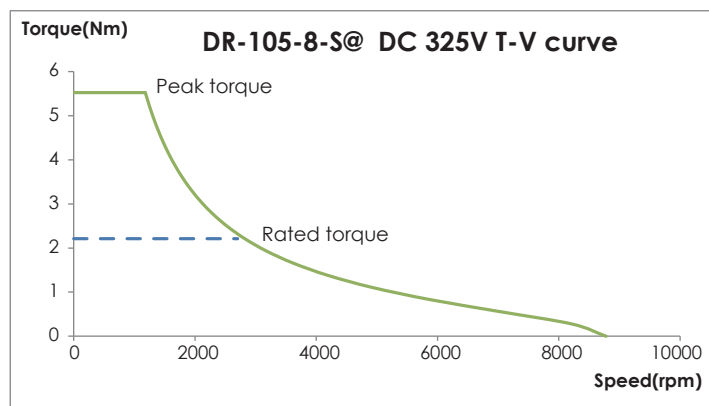

Torque / Speed Curve

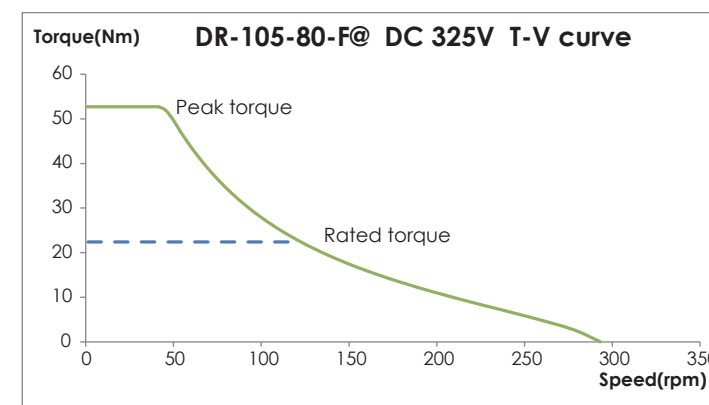
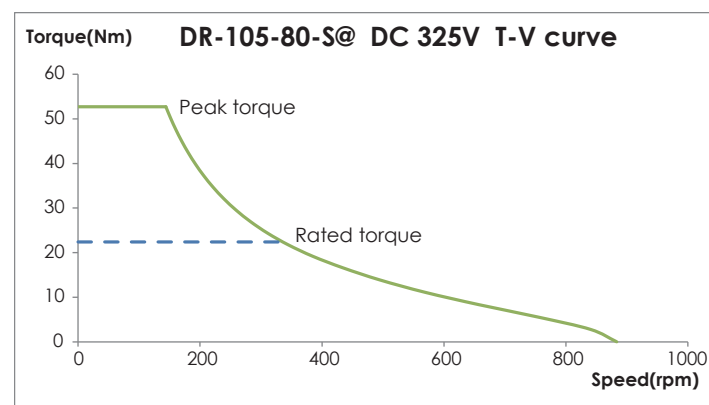
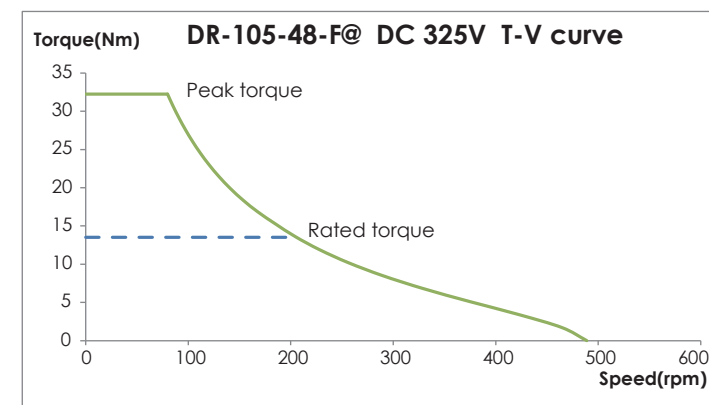
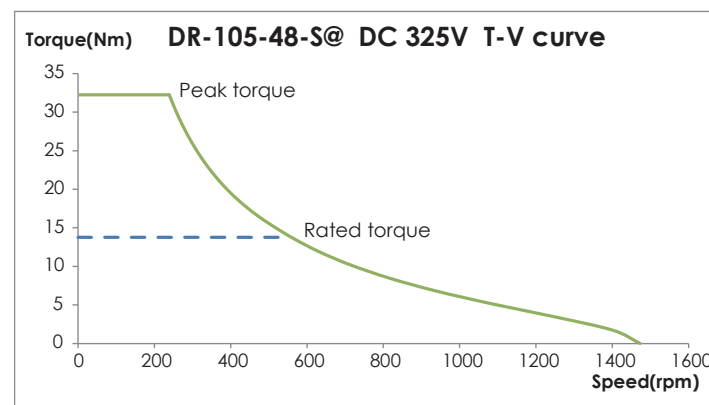

Dimension

Unit: mm

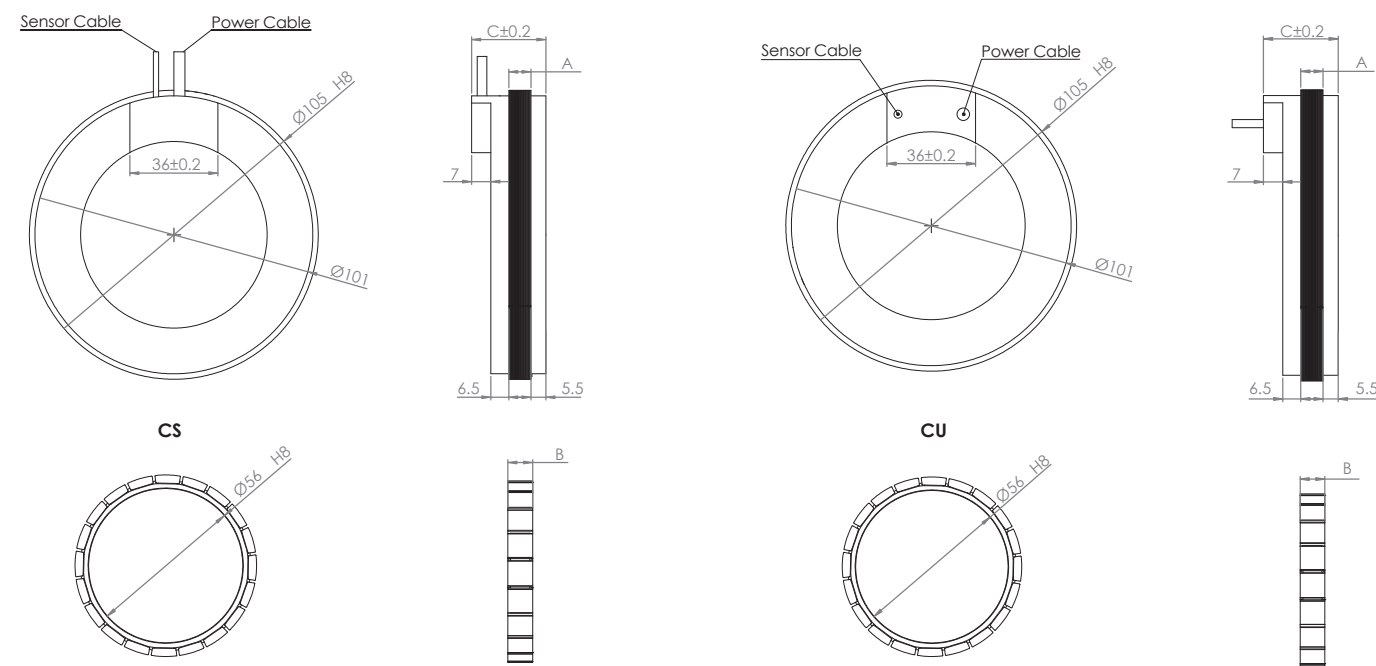

OUTPUT CABLE (All cable standard length is 400 mm)

Motor Wire Table			Hall Sensor Wire Table and Thermal Protection Wire Table					
Pin Number	Function	Cross section	Color	Function	Cable Dia.	Color	Function	Cable Dia.
White	U phase	0.5 mm ²	Pink	Hall A U phase	0.14 mm ²	Brown	Thermal sensor	0.14 mm ²
Yellow	V phase	0.5 mm ²	Yellow	Hall B V phase	0.14 mm ²	Blue		
Brown	W phase	0.5 mm ²	Green	Hall C W phase	0.14 mm ²		Shielding	
Green	PE + shielding	0.5 mm ²	Grey	Hall IC + 5V	0.14 mm ²			
			White	GND	0.14 mm ²			

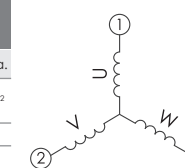

DIMENSIONS

Type	A	B	C
DR-105-8	8	9	27
DR-105-16	16	17	35
DR-105-24	24	25	43
DR-105-34	32	33	51
DR-105-48	48	49	67
DR-105-80	80	81	99



DR-140

	Unit	cpc											
		3-phase synchronous frameless Torque											
Coil assembly model		DR-140-8		DR-140-16		DR-140-24		DR-140-30		DR-140-50		DR-140-70	
Winding code		S	F	S	F	S	F	S	F	S	F	S	F
Performance													
Peak torque ⁽²⁾⁽³⁾	Nm	12	24	36	45	79.5	103.6						
Continuous torque with heat sink ⁽¹⁾⁽²⁾	Nm	4.8	9.6	14.4	18	31.8	41.4						
Continuous torque without heat sink ⁽²⁾⁽³⁾	Nm	2.9	5.8	8.6	10.8	19.1	24.7						
Maximum speed AC 420V@DC 600V	rpm	40514	8268	20776	4198	13970	2813	11253	2250	6380	1272	4852	969
Mechanical													
Stator OD	mm	140											
Rotor ID	mm	60											
Lamination stack height	mm	8	16	24	30	50	70						
Rotor inertia	kg*m ²	3.99*10 ⁻⁴	7.55*10 ⁻⁴	1.11*10 ⁻³	1.38*10 ⁻³	2.27*10 ⁻³	3.2*10 ⁻³						
Stator mass	kg	1.12	1.53	1.96	2.35	3.48	4.63						
Rotor mass	kg	0.26	0.5	0.69	0.89	1.46	2.04						
Total mass	kg	0.82	1.61	2.36	2.98	4.94	6.91						
Electrical													
Peak current ⁽²⁾⁽³⁾	A _{pk}	75	15.3	75	15.3	75	15.3	75	15	75	15	74.5	14.8
Continuous current with heat sink ⁽¹⁾⁽²⁾	A _{pk}	30	6.1	30	6.1	30	6.1	30	6	30	6	29.8	5.9
Continuous current without heat sink ⁽²⁾⁽³⁾	A _{pk}	18	3.7	18	3.7	18	3.7	18	3.6	18	3.6	17.8	3.5
Max. current (Linear range) ⁽²⁾	A _{pk}	30	6.1	30	6.1	30	6.1	30	6	30	6	29.8	5.9
Motor torque constant	Nm/A _{pk}	0.16	0.82	0.32	1.61	0.48	2.4	0.6	3	1.06	5.3	1.39	6.96
Back EMF constant ⁽²⁾	V/rad/s	0.20	0.98	0.39	1.93	0.58	2.88	0.72	3.6	1.27	6.37	1.67	8.36
Resistance	Ω	0.10	2.43	0.12	3.05	0.15	3.66	0.16	4.12	0.23	5.65	0.29	7.18
Inductance	mH	0.87	21.14	1.33	33.86	1.85	45.02	2.11	54.38	3.43	84.19	4.55	112.73
Time constant ⁽²⁾	ms	8.7	11.1	12.3	13.2	14.9	15.7						
Thermal resistance without heat sink ⁽²⁾⁽³⁾	°C/W	2.56	2.04	1.70	1.59	1.16	0.97						
Thermal resistance with heat sink ⁽¹⁾⁽²⁾	°C/W	0.94	0.75	0.62	0.57	0.42	0.34						
Motor constant ⁽²⁾	N/√W	0.51	0.92	1.24	1.5	2.21	2.58						
Magnet poles	N(2τ)	20											
Rated voltage	V	600V _{dc} / 420V _{ac}											
Ph-PE dielectric strength		≥ 1850V(AC)											
Ph-PE insulation resistance		≥ 3100V(DC)											

(1) This value applies to the static sinusoidal drive under specific heat sink and temperature ranges from 25°C up to 110°C. The actual performance is dependent on the heat sink configuration, system cooling condition and ambient temperature.

(2) The tolerance levels for the total performance and electrical specification is ±10%

(3) This value applies to static sinusoidal drive operating under temperatures from 25°C up to 110°C, without heat sink.

(4) The above "without heat sink" figure assumes a working condition of 1 atm, 25°C ambient temperature, in which the linear motor is stationary and not in contact with any other objects, relying only on free air convection for cooling. As all heat conductive objects in direct contact with the motor, including the plate, bearing and housing, can be considered a kind of heat sink, the "with heat sink" figure should be taken as the primary reference in actual application design.

Torque / Speed Curve

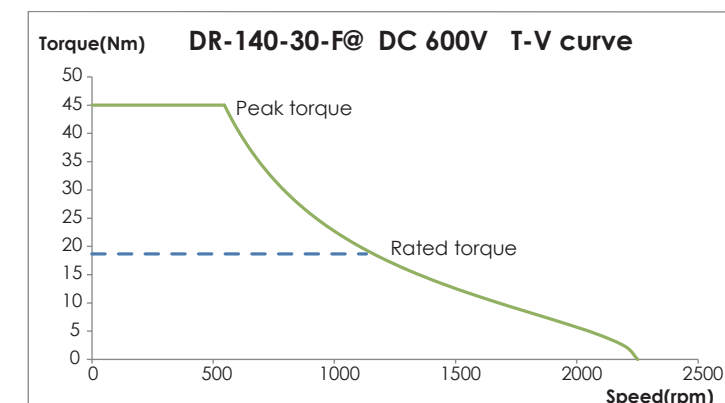
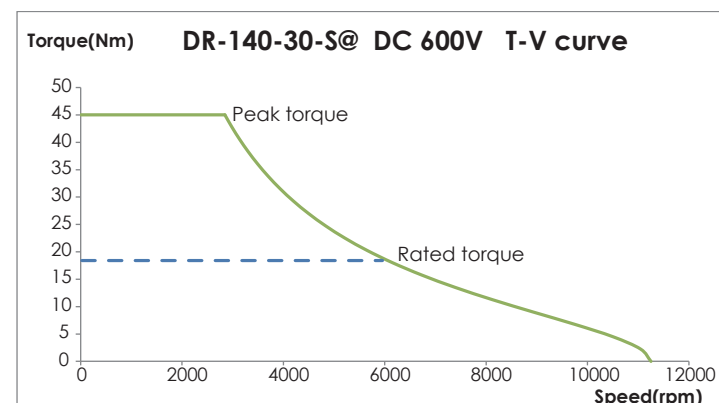
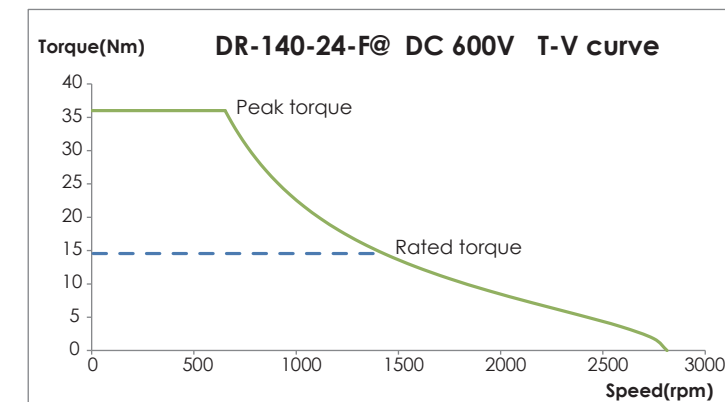
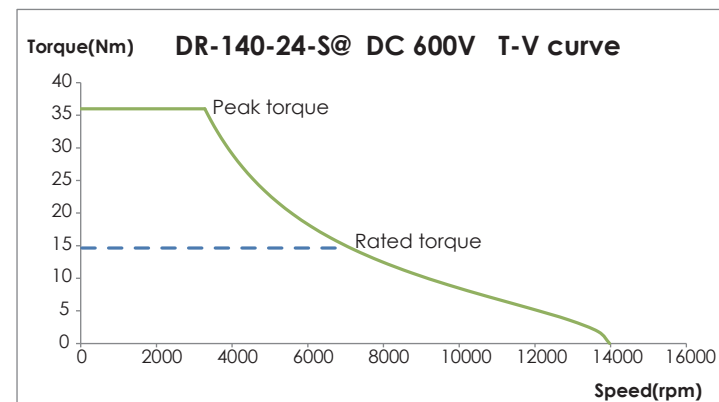
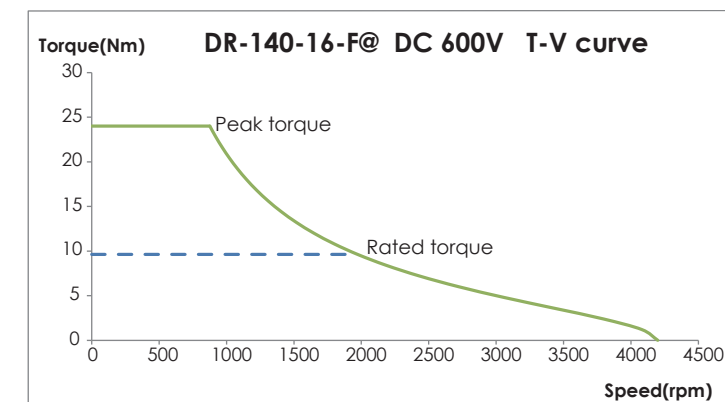
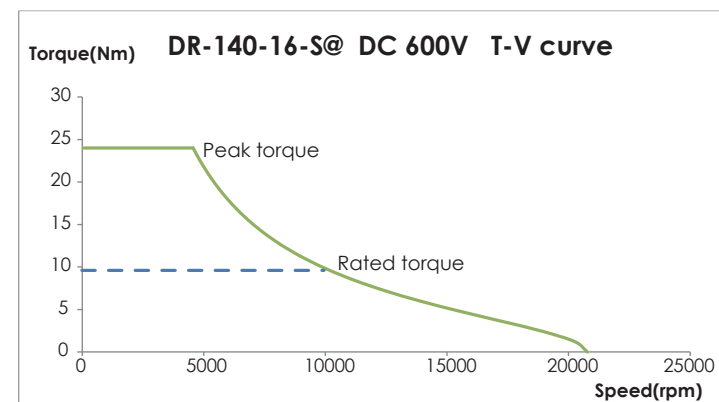
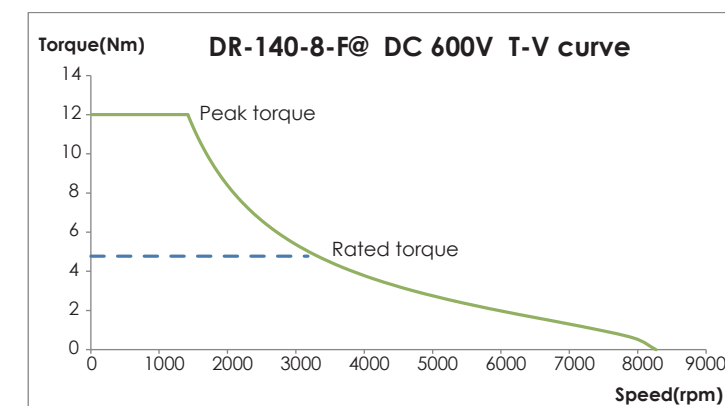
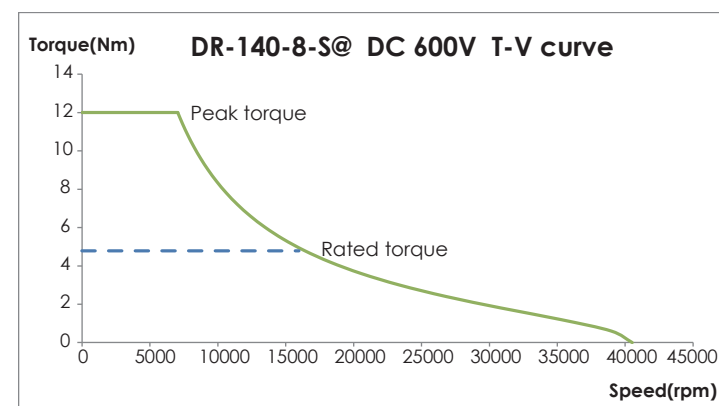

Torque / Speed Curve

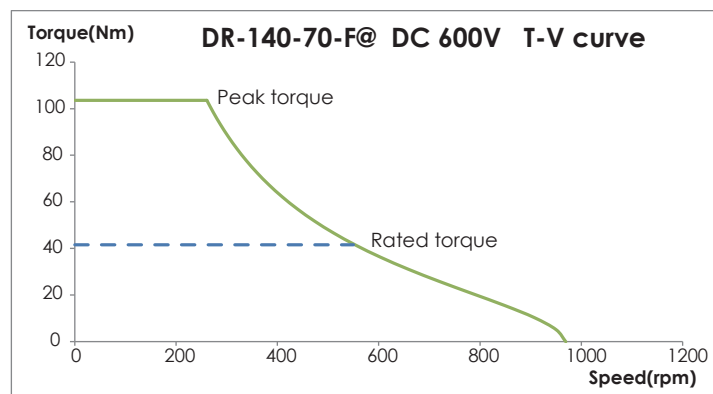
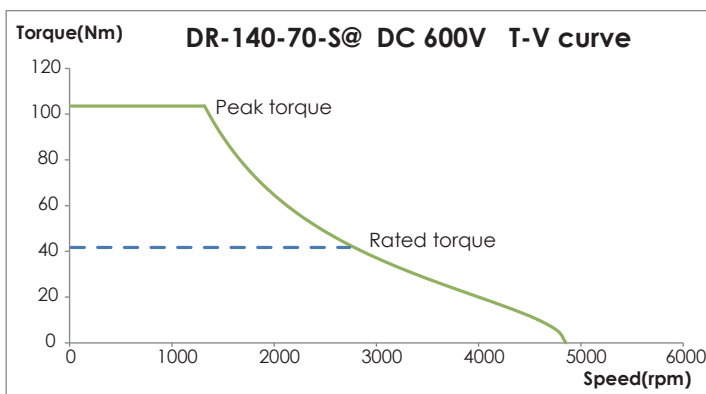
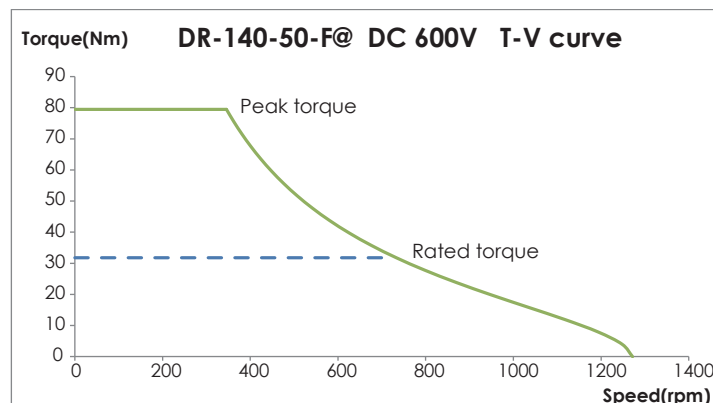
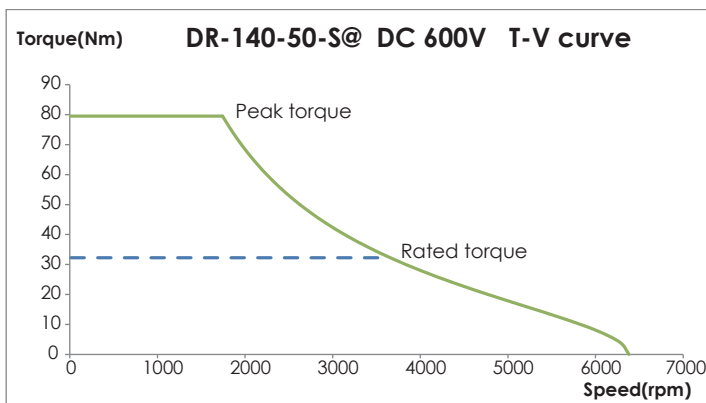

DR-175 series

DR-175

		cpc																				
		3-phase synchronous frameless Torque																				
Coil assembly model		DR-175-8			DR-175-16			DR-175-24			DR-175-30			DR-175-50			DR-175-70			DR-175-100		
Winding code		S	F	D	S	F	D	S	F	D	S	F	D	S	F	D	S	F	D	S	F	D
Performance																						
Peak torque ⁽²⁾⁽³⁾	Nm	13.5			27.1			40.5			50.5			84.5			118.3			169		
Continuous torque with heat sink ⁽¹⁾⁽²⁾	Nm	5.4			10.8			16.1			20.2			33.8			47.3			67.6		
Continuous torque without heat sink ⁽²⁾⁽³⁾	Nm	3.4			6.8			10.2			12.7			21.2			29.7			42.4		
Maximum speed AC 420V@DC 600V	rpm	5569	11138	27845	2784	5569	13922	1861	3722	9306	1492	2986	7465	892	1785	4463	637	1275	3189	446	892	2231
Mechanical																						
Stator OD	mm	175																				
Rotor ID	mm	90																				
Lamination stack height	mm	8			16			24			30			50			70			100		
Rotor inertia	kg*m ²	1.2x10 ⁻³			2.32x10 ⁻³			3.41x10 ⁻³			4.23x10 ⁻³			7x10 ⁻³			9.77x10 ⁻³			1.39x10 ⁻²		
Stator mass	kg	0.96			1.6			2.24			2.7			4.55			6.37			9.1		
Rotor mass	kg	0.41			0.78			1.14			1.4			2.35			3.28			4.68		
Total mass	kg	1.37			2.38			3.38			4.2			6.9			9.65			13.78		
Electrical																						
Peak current ⁽²⁾⁽³⁾	A _{pk}	10.8	21.5	53.8	10.8	21.5	53.8	10.8	21.5	53.8	10.8	21.5	53.8	10.8	21.5	53.8	10.8	21.5	53.8	10.8	21.5	53.8
Continuous current with heat sink ⁽¹⁾⁽²⁾	A _{pk}	4.3	8.6	21.5	4.3	8.6	21.5	4.3	8.6	21.5	4.3	8.6	21.5	4.3	8.6	21.5	4.3	8.6	21.5	4.3	8.6	21.5
Continuous current without heat sink ⁽²⁾⁽³⁾	A _{pk}	2.7	4.7	11.7	2.7	4.7	11.7	2.7	4.7	11.7	2.7	4.7	11.7	2.7	4.7	11.7	2.7	4.7	11.7	2.7	4.7	11.7
Max. current (Linear range) ⁽²⁾	A _{pk}	8	16	40	8	16	40	8	16	40	8	16	40	8	16	40	8	16	40	8	16	40
Motor torque constant	Nm/A _{pk}	1.26	0.63	0.25	2.52	1.26	0.5	3.77	1.89	0.75	4.7	2.35	0.94	7.86	3.93	1.57	11	5.5	2.2	15.72	7.86	3.14
Back EMF constant ⁽²⁾	V/rad/s	1.45	0.73	0.29	2.91	1.45	0.58	4.35	2.18	0.87	5.43	2.71	1.09	9.08	4.54	1.82	12.7	6.35	2.54	18.15	9.08	3.63
Resistance	Ω	3.16	0.79	0.13	3.81	0.95	0.15	5.37	1.34	0.21	6.2	1.55	0.25	8.96	2.24	0.36	11.89	2.97	0.48	15.86	3.97	0.63
Inductance	mH	24.33	6.08	0.97	29.34	7.33	1.17	41.35	10.34	1.65	47.74	11.94	1.91	68.99	17.25	2.76	91.55	22.89	3.66	122.3	30.58	4.89
Time constant ⁽²⁾	ms	7.7	7.7	7.7	7.7	7.7	7.7	7.7	7.7	7.7	7.7	7.7	7.7	7.7	7.7	7.7	7.7	7.7	7.7	7.7	7.7	7.7
Thermal resistance without heat sink ⁽²⁾⁽³⁾	°C/W	3.4			2.5			1.98			1.7			1.2			0.9			0.68		
Thermal resistance with heat sink ⁽¹⁾⁽²⁾	°C/W	1.36			1			0.8			0.68			0.47			0.36			0.27		
Motor constant ⁽²⁾	N/√W	0.71			1.29			1.63			1.89			2.63			3.19			3.95		
Magnet poles	N(2τ)	40																				
Rated voltage	V	600V _{ac} / 420V _{dc}																				
Ph-PE dielectric strength		≥ 1850V(AC)																				
Ph-PE insulation resistance		≥ 3100V(DC)																				

- (1) This value applies to the static sinusoidal drive under specific heat sink and temperature ranges from 25°C up to 110°C. The actual performance is dependent on the heat sink configuration, system cooling condition and ambient temperature.
- (2) The tolerance levels for the total performance and electrical specification is ±10%
- (3) This value applies to static sinusoidal drive operating under temperatures from 25°C up to 110°C, without heat sink.
- (4) The above "without heat sink" figure assumes a working condition of 1 atm, 25°C ambient temperature, in which the linear motor is stationary and not in contact with any other objects, relying only on free air convection for cooling. As all heat conductive objects in direct contact with the motor, including the plate, bearing and housing, can be considered a kind of heat sink, the "with heat sink" figure should be taken as the primary reference in actual application design.

Dimension

Unit: mm

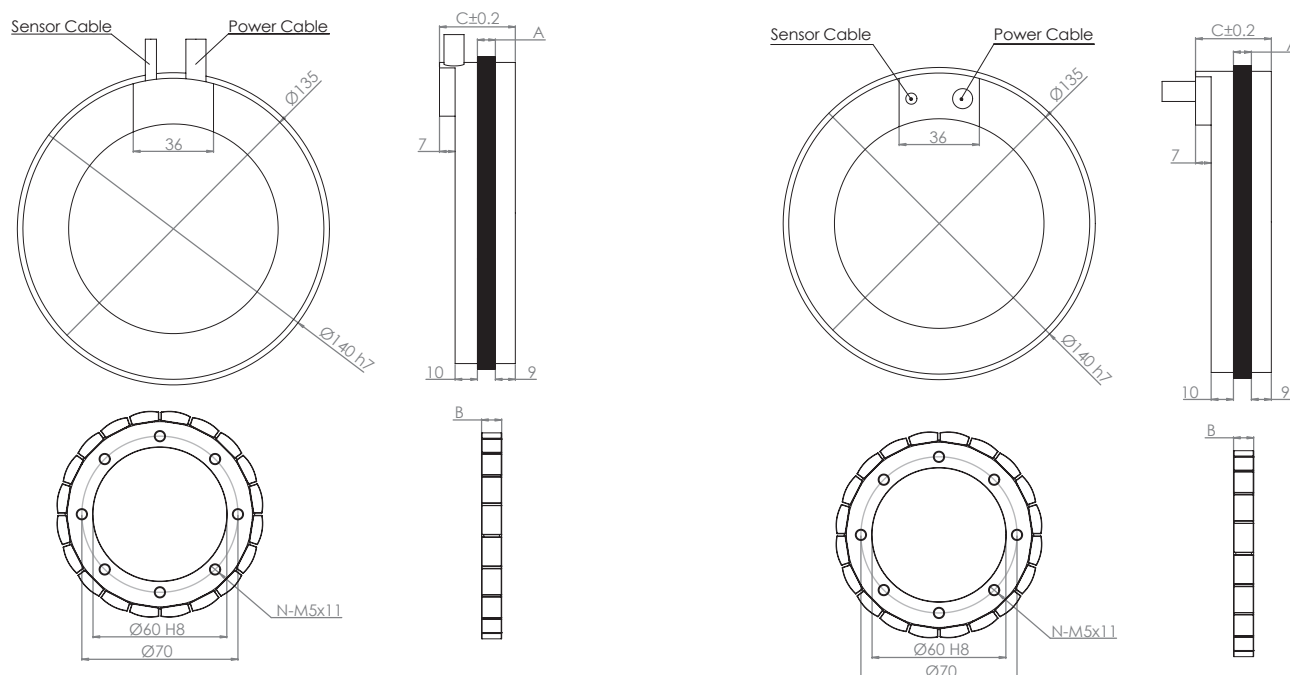

OUTPUT CABLE (All cable standard length is 400 mm)

Motor Wire Table			Hall Sensor Wire Table and Thermal Protection Wire Table					
Pin Number	Function	Cross section	Color	Function	Cable Dia.	Color	Function	Cable Dia.
White (1)	U phase	1.5 mm ²	Pink	Hall A U phase	0.14 mm ²	Brown	Thermal sensor	0.14 mm ²
Yellow (2)	V phase	1.5 mm ²	Yellow	Hall B V phase	0.14 mm ²	Blue		
Brown (3)	W phase	1.5 mm ²	Green	Hall C W phase	0.14 mm ²		Shielding	
Green	PE + shielding	1.5 mm ²	Grey	Hall IC + 5V	0.14 mm ²			
			White	GND	0.14 mm ²			

DIMENSIONS

Type	N	A	B	C
DR-140-08	8	9	34	
DR-140-16	16	17	42	
DR-140-24	24	25	50	
DR-140-30	30	31	56	
DR-140-50	50	51	76	
DR-140-70	70	71	96	

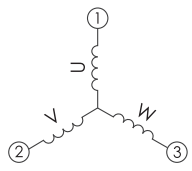

Torque / Speed Curve

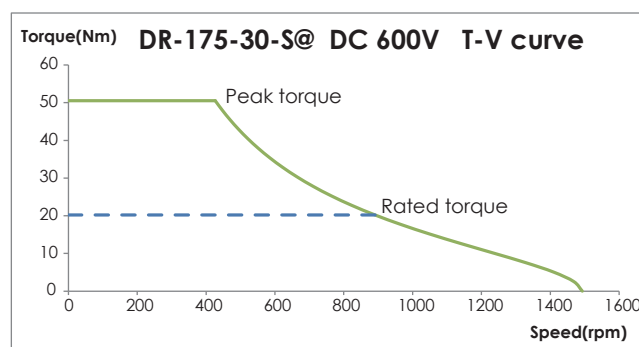
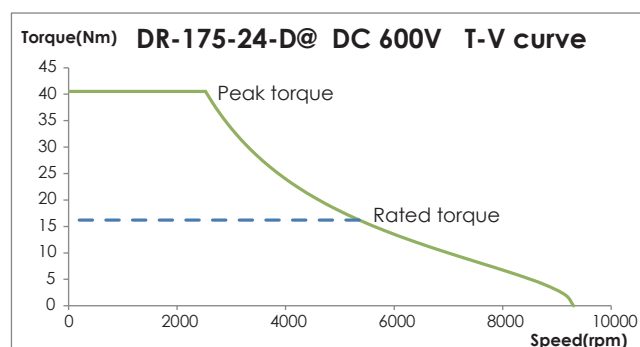
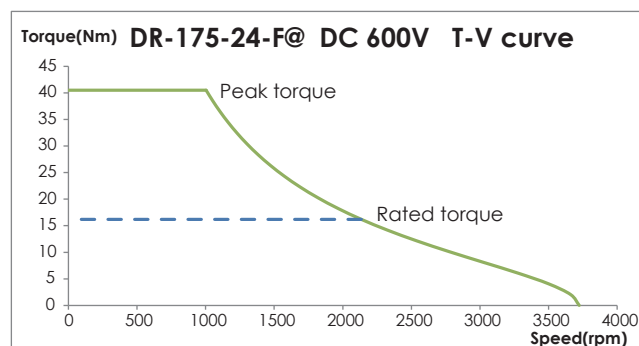
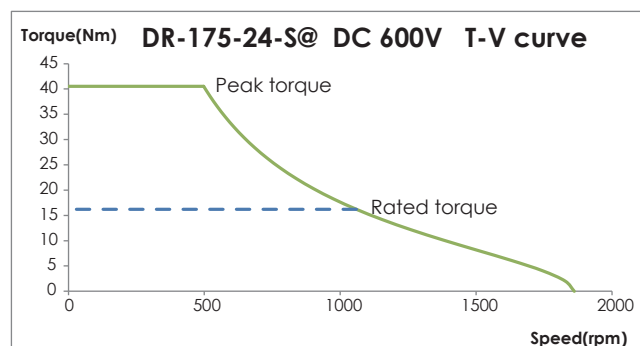
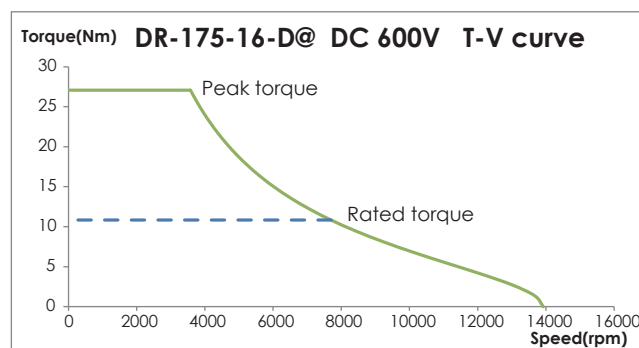
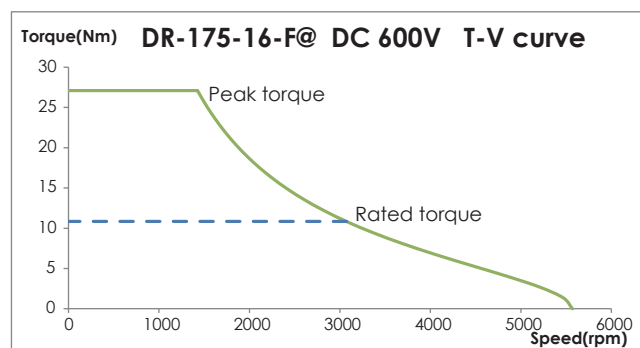
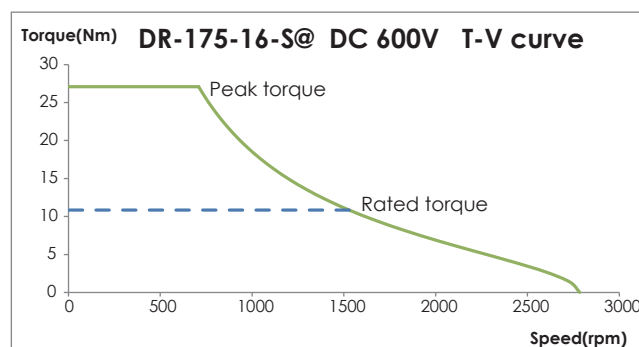
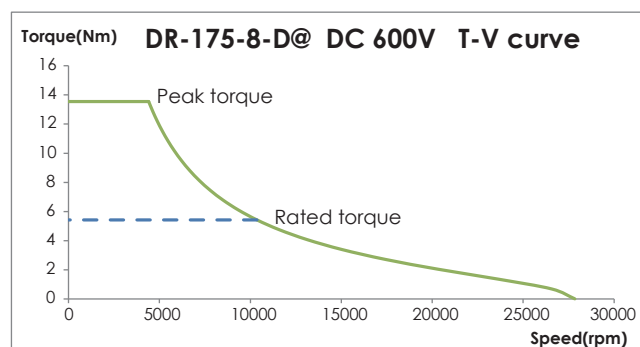
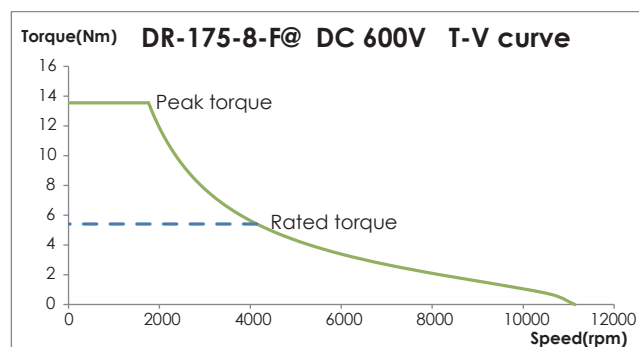
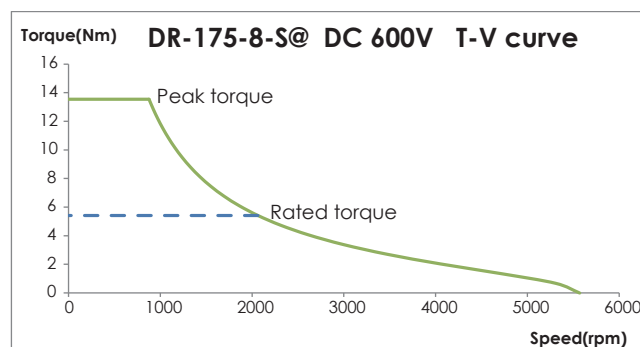

Torque / Speed Curve

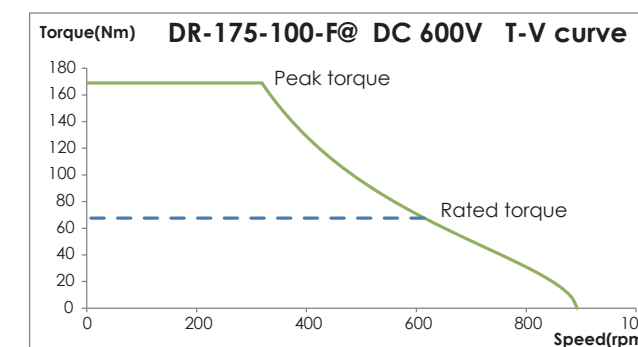
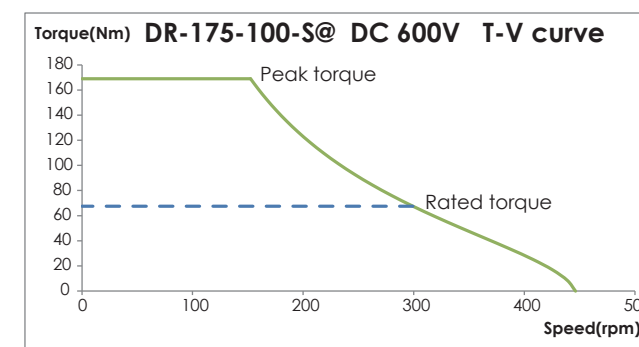
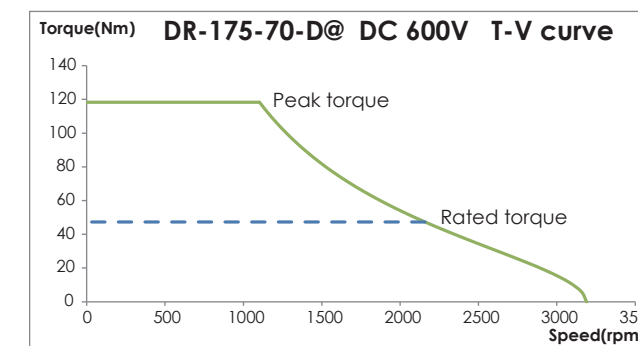
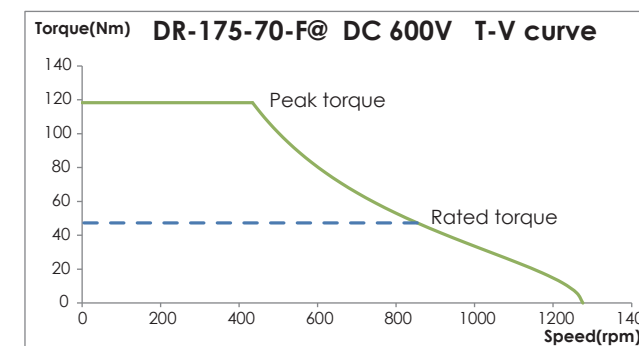
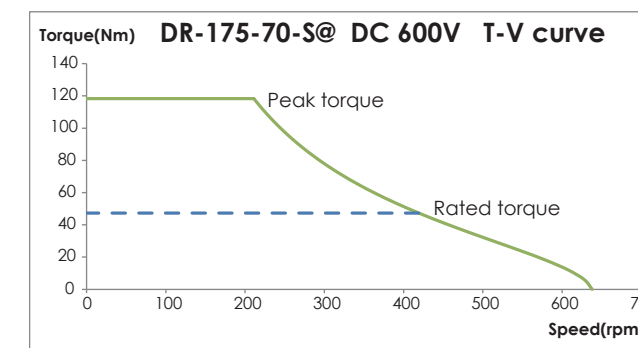
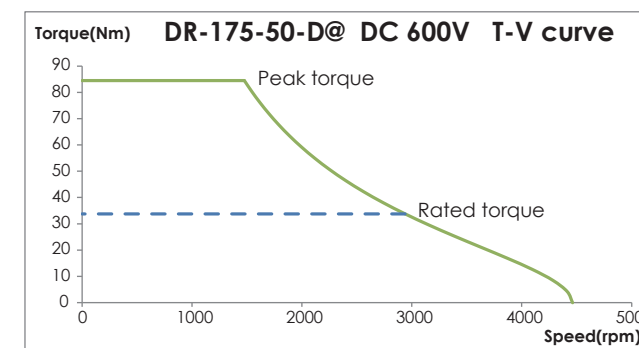
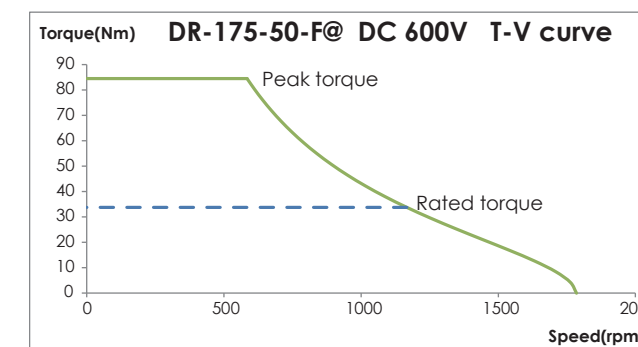
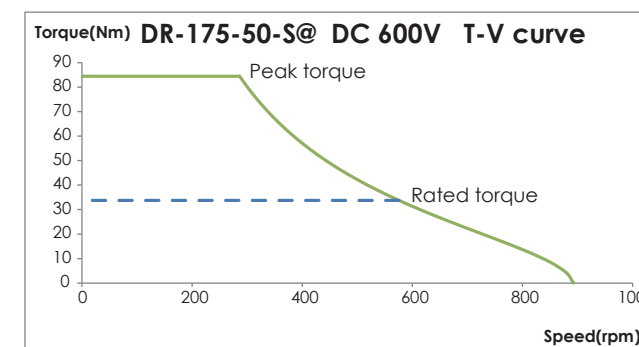
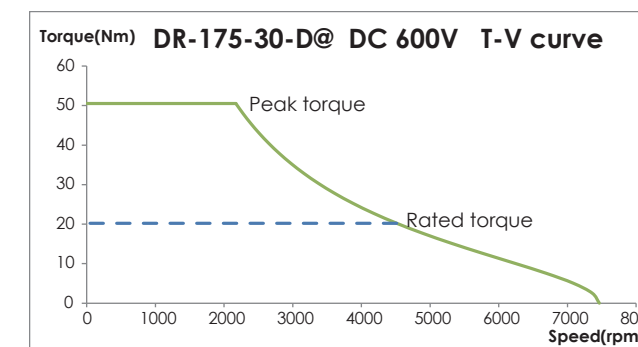
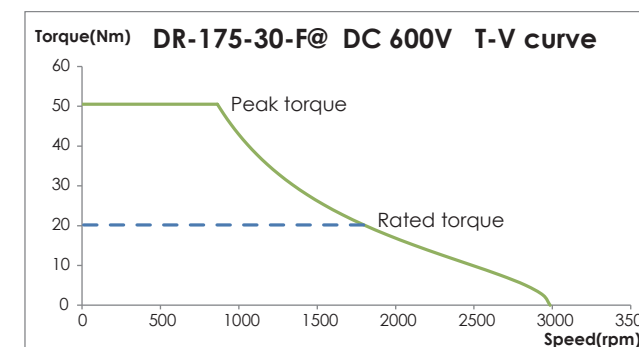

Torque / Speed Curve

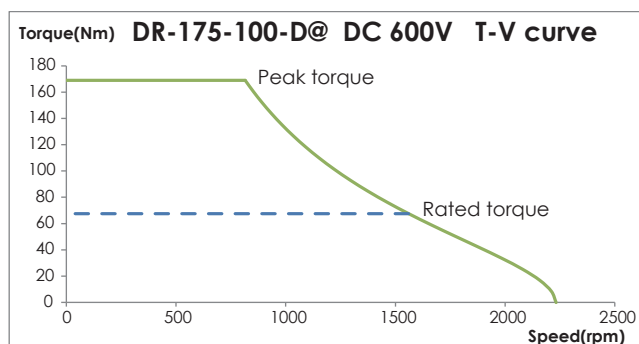

Dimension

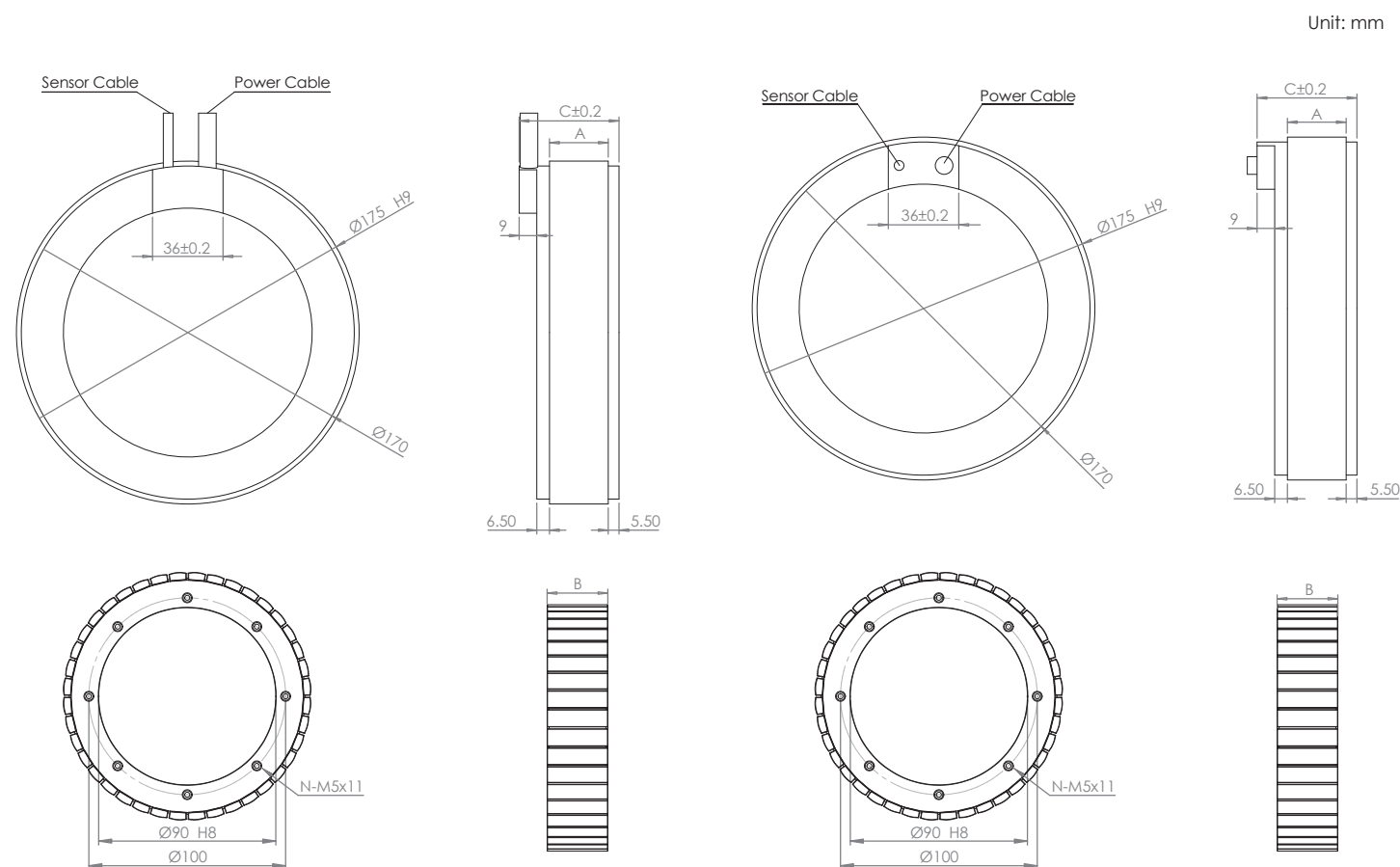

OUTPUT CABLE (All cable standard length is 400 mm)

Motor Wire Table			Hall Sensor Wire Table and Thermal Protection Wire Table					
Pin Number	Function	Cross section	Color	Function	Cable Dia.	Color	Function	Cable Dia.
White	U phase	1.5 mm ²	Pink	Hall A U phase	0.14 mm ²	Brown	Thermal sensor	0.14 mm ²
Yellow	V phase	1.5 mm ²	Yellow	Hall B V phase	0.14 mm ²	Blue		
Brown	W phase	1.5 mm ²	Green	Hall C W phase	0.14 mm ²		Shielding	
Green	PE + shielding	1.5 mm ²	Grey	Hall IC + 5V	0.14 mm ²			
			White	GND	0.14 mm ²			

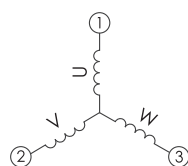

DIMENSIONS

Type	A	B	C
DR-175-8	8	9	29
DR-175-16	16	17	37
DR-175-24	24	25	45
DR-175-30	30	31	51
DR-175-50	50	51	71
DR-175-70	70	71	91
DR-175-100	100	101	121



DR-210

	Unit	cpc			
Coil assembly model		3-phase synchronous frameless Torque			
Winding code		DR-210-30	DR-210-50	DR-210-70	DR-210-100
Performance					
Peak torque ⁽²⁾⁽³⁾	Nm	123.7	206.2	288.6	412.3
Continuous torque with heat sink ⁽¹⁾⁽²⁾	Nm	49.7	82.9	116.1	165.8
Continuous torque without heat sink ⁽²⁾⁽³⁾	Nm	22.9	38.1	53.3	76.2
Maximum speed AC 420V@DC 600V	rpm	1565	939	671	469
Mechanical					
Stator OD	mm	210			
Rotor ID	mm	140			
Lamination stack height	mm	30	50	70	100
Rotor inertia	kg*m ²	8.9x10 ⁻²	1.4x10 ⁻¹	2.07x10 ⁻¹	2.99x10 ⁻¹
Stator mass	kg	3.3	4.8	6.31	8.56
Rotor mass	kg	1.5	2.48	3.49	4.96
Total mass	kg	4.8	7.28	9.8	13.52
Electrical					
Peak current ⁽²⁾⁽³⁾	A _{pk}	27.6	27.6	27.6	27.6
Continuous current with heat sink ⁽¹⁾⁽²⁾	A _{pk}	11.1	11.1	11.1	11.1
Continuous current without heat sink ⁽²⁾⁽³⁾	A _{pk}	5.1	5.1	5.1	5.1
Max. current (Linear range) ⁽²⁾	A _{pk}	12	12	12	12
Motor torque constant	Nm/A _{pk}	4.48	7.47	10.46	14.94
Back EMF constant ⁽²⁾	V/rad/s	5.18	8.63	12.08	17.25
Resistance	Ω	1.6	2.22	2.86	3.82
Inductance	mH	17.13	23.4	30.14	40.3
Time constant ⁽²⁾	ms	10.54	10.54	10.54	10.54
Thermal resistance without heat sink ⁽²⁾⁽³⁾	°C/W	2.05	1.5	1.17	0.87
Thermal resistance with heat sink ⁽¹⁾⁽²⁾	°C/W	0.43	0.32	0.25	0.19
Motor constant ⁽²⁾	N/√W	3.52	5.01	6.18	7.64
Magnet poles	N(2τ)	40			
Rated voltage	V	600V _{dc} / 420V _{ac}			
Ph-PE dielectric strength		≥ 1850V(AC)			
Ph-PE insulation resistance		≥ 3100V(DC)			

(1) This value applies to the static sinusoidal drive under specific heat sink and temperature ranges from 25°C up to 110°C. The actual performance is dependent on the heat sink configuration, system cooling condition and ambient temperature.

(2) The tolerance levels for the total performance and electrical specification is ±10%

(3) This value applies to static sinusoidal drive operating under temperatures from 25°C up to 110°C, without heat sink.

(4) The above "without heat sink" figure assumes a working condition of 1 atm, 25°C ambient temperature, in which the linear motor is stationary and not in contact with any other objects, relying only on free air convection for cooling. As all heat conductive objects in direct contact with the motor, including the plate, bearing and housing, can be considered a kind of heat sink, the "with heat sink" figure should be taken as the primary reference in actual application design.

Torque / Speed Curve

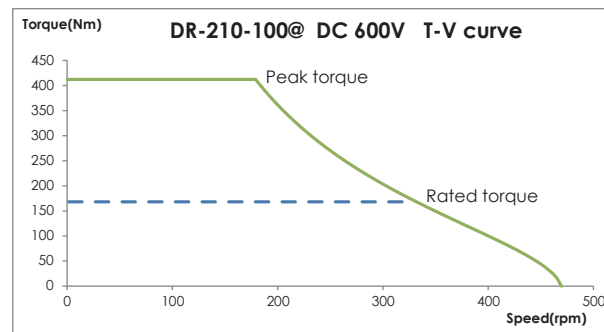
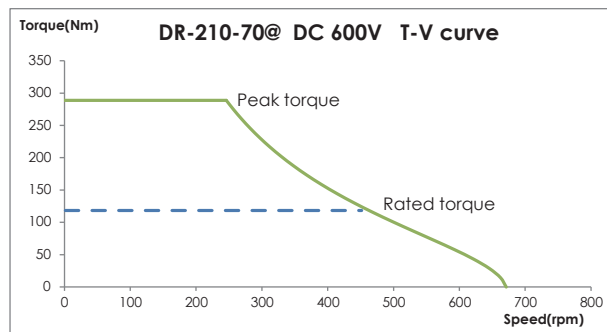
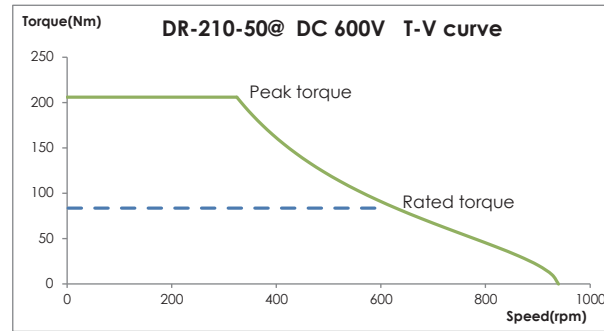
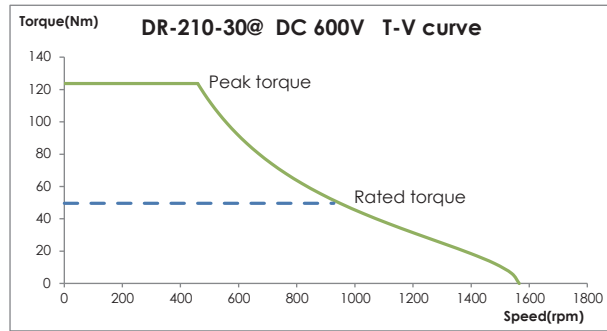

Dimension

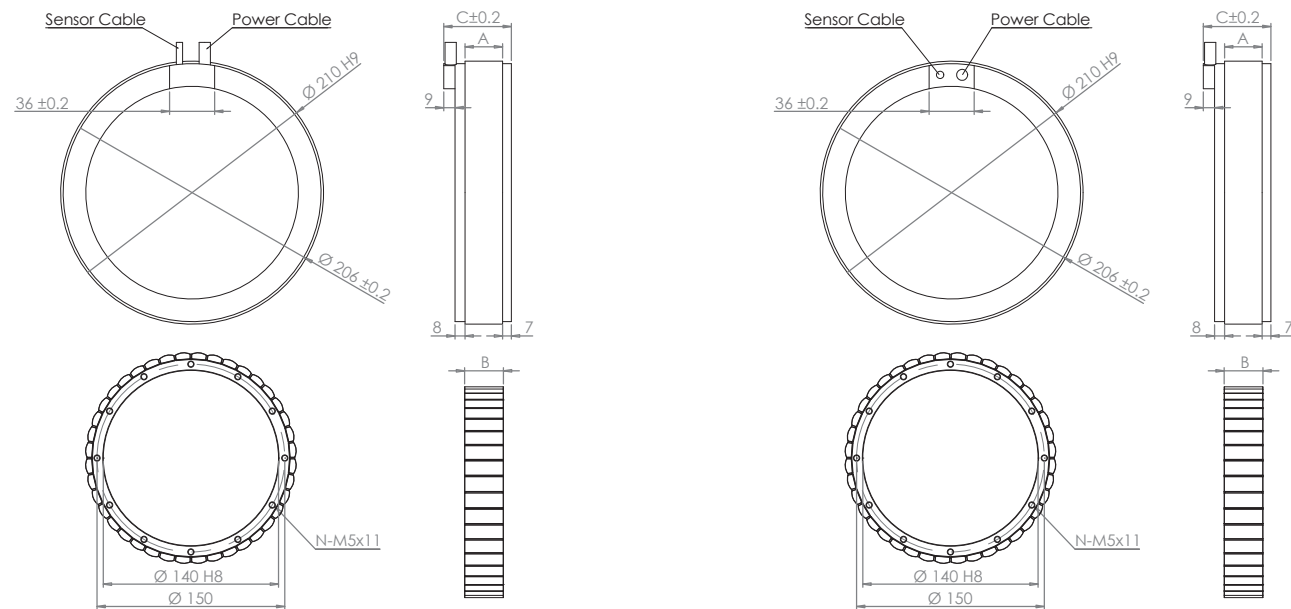

OUTPUT CABLE (All cable standard length is 400 mm)

Motor Wire Table			Hall Sensor Wire Table and Thermal Protection Wire Table					
Pin Number	Function	Cross section	Color	Function	Cable Dia.	Color	Function	Cable Dia.
White	U phase	1.5 mm ²	Pink	Hall A U phase	0.14 mm ²	Brown	Thermal sensor	0.14 mm ²
Yellow	V phase	1.5 mm ²	Yellow	Hall B V phase	0.14 mm ²	Blue		
Brown	W phase	1.5 mm ²	Green	Hall C W phase	0.14 mm ²		Shielding	
Green	PE + shielding	1.5 mm ²	Grey	Hall IC + 5V	0.14 mm ²			
			White	GND	0.14 mm ²			

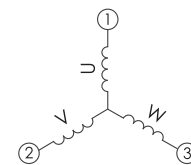

DIMENSIONS			
Type	A	B	C
DR-210-30	30	31	54
DR-210-50	50	51	74
DR-210-70	70	71	94
DR-210-100	100	101	124

cpcCells

Not only for users, but also for designers
cpc's products inspire you!
 Together with cpc to achieve new levels of innovation!

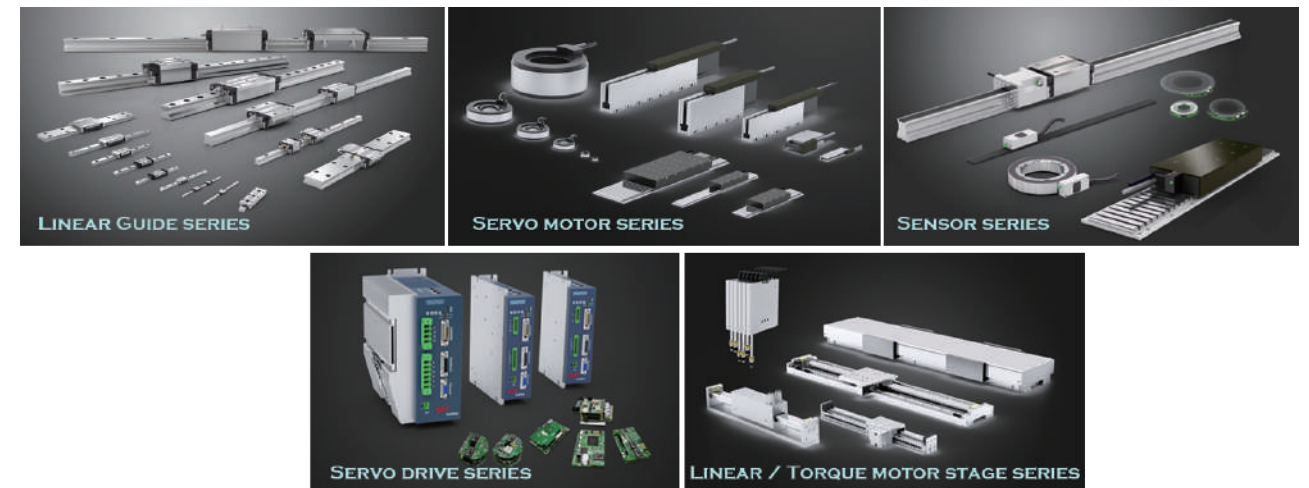

www.chieftek.com



YouTube